



**DRAFT**

**Preliminary Low Impact  
Development Report  
(LID)**

For

**MT SAC STUDENT CENTER**

**PREPARED FOR:**

Mt. SAC  
Facilities Planning & Management  
1100 N. Grand Ave  
Walnut, CA 91789

**PREPARED BY:**

BKF Engineers  
4675 MacArthur Court, Suite 400  
Newport Beach, CA 92660

---

**LID Report Prepared: September 27<sup>th</sup>,**



---

Bruce Kirby, PE  
R.C.E. No. 42393  
Expires: 03/31/20

**BKF Engineers**

**4675 MacArthur Court Suite 400 | Newport Beach, California 92660**

**Engineers | Surveyors | Planners**

## TABLE OF CONTENTS

<b>1.0</b>	<b>INTRODUCTION</b> .....	<b>4</b>
1.1	SITE AND PROJECT DESCRIPTION.....	4
<b>2.0</b>	<b>DESIGNATED PROJECT REQUIREMENT</b> .....	<b>4</b>
2.1	DETERMINATION FOR PERMANENT BMP REQUIREMENT.....	5
2.2	DESIGN PROCESS CHART BREAKDOWN.....	6
<b>3.0</b>	<b>SITE ASSESSMENT AND DESIGN CONSIDERATIONS</b> .....	<b>7</b>
3.1	VICINITY MAP.....	7
3.2	PROJECT SUMMARY INFORMATION.....	8
3.3	WATERSHED.....	8
3.4	GEOTECHNICAL CONDITIONS.....	9
3.5	GEOTECHNICAL HAZARDS.....	9
3.6	SITE DESIGN PRINCIPLES.....	9
<b>4.0</b>	<b>SOURCE CONTROL MEASURES</b> .....	<b>10</b>
<b>5.0</b>	<b>STORMWATER QUALITY DESIGN VOLUME CALCULATIONS</b> .....	<b>16</b>
5.1	DESIGN STORM EVENT.....	17
5.2	STORMWATER QUALITY DESIGN VOLUME (SWQDV).....	17
<b>6.0</b>	<b>STORMWATER QUALITY CONTROL MEASURES</b> .....	<b>18</b>
6.1	UNDERGROUND INFILTRATION SIZING.....	19
<b>7.0</b>	<b>HYDROMODIFICATION</b> .....	<b>19</b>
<b>8.0</b>	<b>STORMWATER QUALITY CONTROL MEASURE MAINTENANCE</b> .....	<b>20</b>
8.1	MAINTENANCE RESPONSIBILITY.....	20
8.2	INSPECTION AND MAINTENANCE FOR SOURCE CONTROL MEASURES.....	20
8.3	INSPECTION AND MAINTENANCE FOR STORM QUALITY MEASURES.....	21
8.4	INSPECTION AND MAINTENANCE FREQUENCY.....	21
8.5	RECORD KEEPING REQUIREMENTS.....	22
<b>9.0</b>	<b>SUMMARY</b> .....	<b>22</b>

## **APPENDICES**

APPENDIX A – VICINITY MAP

APPENDIX B – BMP SITE PLAN

APPENDIX C – COUNTY OF LOS ANGELES HYDROLOGY MAPS

APPENDIX D – HYDROCALC OUTPUT - 85<sup>TH</sup> PERCENTILE STORM

APPENDIX E – STORMWATER QUALITY DESIGN MEASURE CALCULATIONS

APPENDIX F – BMP FACT SHEETS

APPENDIX G – BMP OPERATIONS & MAINTENANCE MANUAL

APPENDIX H – COVENANT AND AGREEMENT

APPENDIX I – GEOTECHNICAL REPORT (FOR REFERENCE ONLY)

## OWNER'S CERTIFICATION

This Low Impact Development Report (LID) for the Mt. SAC Student Center Project prepared for Mt. SAC by BKF Engineers. This LID Report is intended to comply with the requirements of the City of Walnut, County of Los Angeles, requiring the preparation of a project specific LID Report.

I certify under penalty of law that this document and all attachments were prepared under my jurisdiction or supervision in accordance with a system designed to assure that qualified personnel properly gather and evaluate the information submitted. Based on my inquiry of the person or persons who manage the system or those persons directly responsible for the gathered information, to the best of my knowledge and belief, the information submitted is true, accurate, and complete. I am aware that there are significant penalties for submitting false information, including the possibility of fine and imprisonment for knowing violations.

The undersigned, while it owns the subject property, is responsible for the implementation of the provisions of this plan and will ensure that this plan is amended as appropriate to reflect up-to-date conditions on the site consistent with the County of Los Angeles Low Impact Development Standards Manual, and the intent of the stormwater and urban runoff NPDES Permit and Waste Discharge Requirements for the County of Los Angeles, Los Angeles County Flood Control District and the incorporated Cities of Los Angeles County under the jurisdiction of the Los Angeles Regional Water Quality Control Board. A copy of this LID Report will be maintained at the project site/office.

This LID Report will be reviewed with the facility operator, facility supervisors, employees, tenants, maintenance and service contractors, or any other party having responsibility for implementing portions of this LID Report. At least one copy of the approved and certified copy of this LID Report shall be available on the subject property in perpetuity. Once the undersigned transfers its interest in the property, its successors-in-interest shall bear the aforementioned responsibility to implement and amend the LID Report.

<hr style="border: 0.5px solid black;"/> Owner/Engineer of Record's Signature	BKF Engineers <hr style="border: 0.5px solid black;"/> Company
Bruce Kirby, P.E. <hr style="border: 0.5px solid black;"/> Printed Name/Title	4675 MacArthur Court, Suite 400 Newport Beach, CA 92660 <hr style="border: 0.5px solid black;"/> Company Address
(949) 526-8460 <hr style="border: 0.5px solid black;"/> Telephone No.	9/21/2018 <hr style="border: 0.5px solid black;"/> Date



## 1.0 INTRODUCTION

This Low Impact Development Report (LID) summarizes storm water protection requirements for the Mt. SAC Student Center (herein referred to as “the project”).

This LID Report describes the permanent storm water Best Management Practices (BMPs) that will be incorporated into the project in order to mitigate the impacts of pollutants in storm water runoff from the proposed project. For the purposes of post-construction storm water quality management, the project will follow the guidelines and requirements set forth in the County of Los Angeles “Low Impact Development Standards Manual” dated February 2014 (herein “LID Manual”).

Project Applicant: Mt. SAC  
1100 N. Grand Ave  
Walnut, CA 91789

### 1.1 SITE AND PROJECT DESCRIPTION

The subject site is located in the City of Walnut, Los Angeles County, California. The proposed student center will be located at near the center of campus. The existing site is currently occupied by 3 concrete buildings, 4 trailer buildings, PCC walkways and landscaped areas. The proposed project will consist of:

- Removal of existing pavement, buildings, landscaping and trees
- Construction of a new 97,000 sf student center
- Installation of (2) underground infiltration vaults

The existing project area has an average slope of 6.1% draining in the southerly direction. Existing drainage is captured within landscape area drains and piped into an underground storm drain system.

Drainage for the proposed student center is designed so that runoff drains away from the building and is captured into a network of area drains in the surrounding landscape along the perimeter of the building. Roof drainage will be conveyed through downspouts which tie into the proposed storm drain system. The stormwater for this site will be routed into underground infiltration vaults to retain runoff for the 85<sup>th</sup> percentile treatment storm.

## 2.0 DESIGNATED PROJECT REQUIREMENT

Requirements for permanent BMPs are determine based on the criteria set forth in the LID Manual. Projects are identified by four categories:

- Designated Project
- Non-Designated Project
- Small-Scale Non-Designated Project
- Large-Scale Non-Designated Project

## **2.1 DETERMINATION FOR PERMANENT BMP REQUIREMENT**

The project is considered a “**Designated Project**,” based on the LID Manual. The project meets the following requirements to be a Designated Project:

1. Parking lots with 5,000 square feet or more of impervious surface area, or with 25 or more parking spaces

All “Designated Projects” must retain 100 percent of the Storm Water Quality Design Volume (SWQDv) on-site through infiltration, evapotranspiration, stormwater runoff harvest and use, or a combination thereof unless it is demonstrated that it is technical infeasible to do so.

The project will retain the SWQDv for the site as outlined in the Design Process Chart Breakdown in Section 2.2. For this project site, an underground infiltration system will be utilized to treat the 12,869 cf of SWQDv. See Section 5.0, Section 6.0 and **Appendix E** for more information and calculations.

## 2.2 DESIGN PROCESS CHART BREAKDOWN

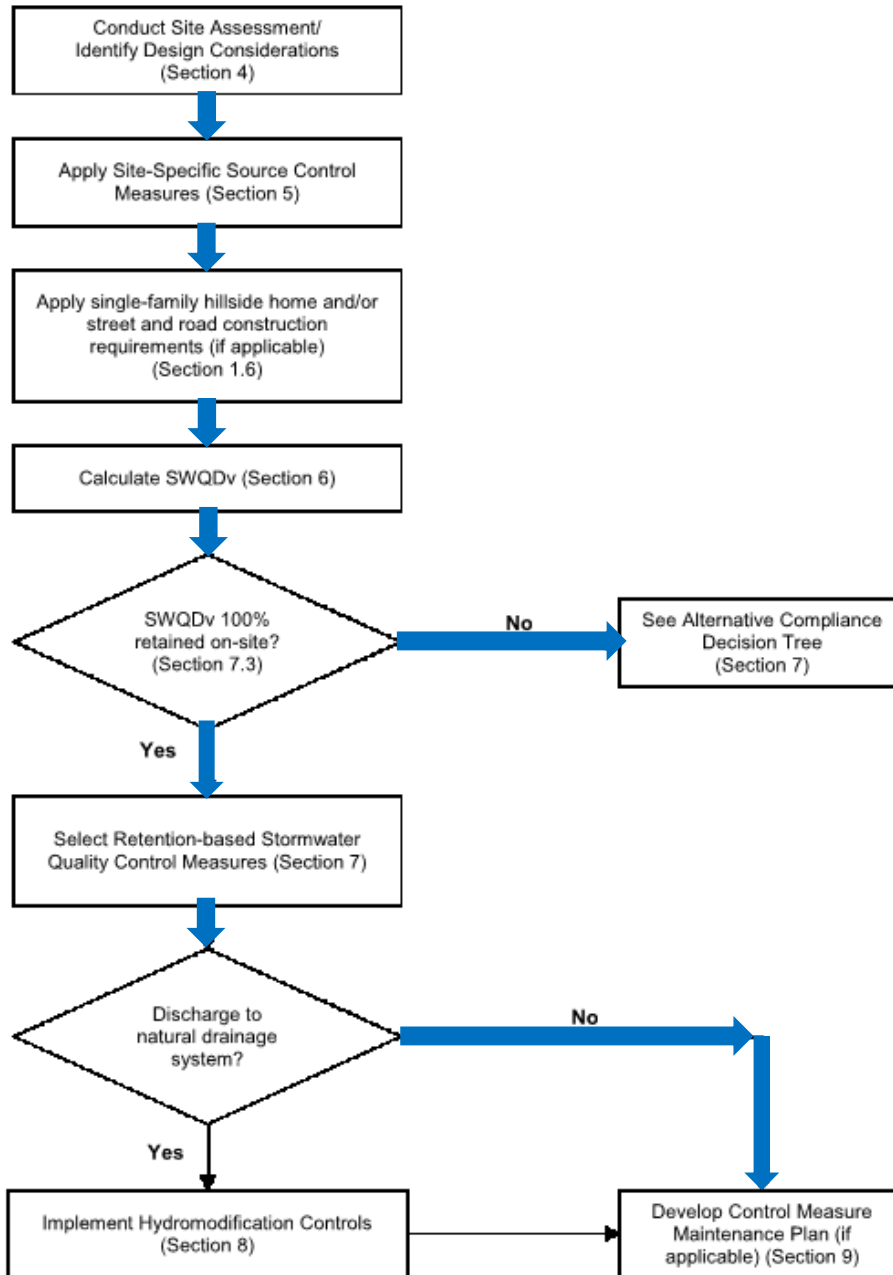

### 3.0 SITE ASSESSMENT AND DESIGN CONSIDERATIONS

This section discusses the steps taken for assessing the project site conditions and identifying design considerations to determine appropriate stormwater quality control measures for the project.

#### 3.1 VICINITY MAP



### **3.2 PROJECT SUMMARY INFORMATION**

#### **Pre-Project**

The existing site is currently occupied by 3 concrete buildings, 4 trailer buildings, PCC walkways and landscaped areas.

The existing project area has an average slope of 6.1% draining in the southerly direction. Existing drainage is captured within landscape area drains and piped into an underground storm drain system.

#### **Post-Project**

In post-project conditions, the project site consists of a student center in place of existing building 17, 1, 19A, and 19B. Storm water runoff at the roof level of the new student center will drain towards a series of inlet grates which convey the captured stormwater through internal storm drain pipes within the parking structure and discharges into underground storm drain pipe on the west side of the parking structure.

The runoff is then routed into underground stormcapture infiltration vaults to the south where the SWQDv will be retained on site while additional overflow is discharged through an emergency outlet that discharges into the existing storm drain system to the south of the project area.

#### **Percent Area Impervious Created or Replaced**

The "Percent Area Impervious Created or Replaced" found was 100%. Since the impervious area created or replaced for the new development is greater than 50% of the impervious area of the previously existing development, the proposed development is required to retain 100% the SWQDv.

### **3.3 WATERSHED**

The proposed development is located within the San Gabriel Watershed and is part of the San Gabriel River Watershed Management Area (SGRWMA). Surface flow from the project enters the municipal storm drain system which outlets into the San Gabriel River and ultimately discharges into the Pacific Ocean.

Region:	Los Angeles Regional Water Quality Control Board (LARWQCB)
Receiving Water:	San Gabriel River
Watershed:	San Jose Creek
303(d) Listing:	Ammonia, Coliform Bacteria, pH, Total Dissolved Solids, Toxicity

### **3.4 GEOTECHNICAL CONDITIONS**

Geotechnical information outlined below was taken from the Geotechnical Report prepared by Converse Consultants dated October 5, 2017.

- Topography: The project site flows across the existing site in the southerly direction at an approximate average slope of 6.1%.
- Geologic Setting: The earth materials encountered during the geotechnical investigation consisted of existing fill soils placed during previous site grading operations and natural alluvial sediments to the depths explored. Undocumented fills, approximately three to five feet in thickness were encountered in the borings. Deeper artificial fill may exist at the site. The fills encountered consisted primarily of silty sands, clayey sands, sandy clays, and silty clayey sands. The alluvial soil deposits below the surface fills primarily consisted of fine-grained clays, clayey sands, silty sands, silts, and sandy silts.
- Groundwater: Groundwater was encountered during the time of drilling in Boring BH-5 at a depth of approximately 47.5 feet bgs.

### **3.5 GEOTECHNICAL HAZARDS**

Geotechnical information outlined below was taken from the Geotechnical Report prepared by Converse Consultants on October 5, 2017.

The site is located within a potential liquefaction zone per the State of California Seismic Hazard Zones Map for the San Dimas Quadrangle as shown in Drawing No. 8 *Seismic Hazard Zones Map*. Liquefaction analyses were performed for the upper 50 feet below ground surface. Results of the liquefaction analyses indicate the site soils are not susceptible to liquefaction.

### **3.6 SITE DESIGN PRINCIPLES**

Site design can protect sensitive environmental features. The intention of site design principles is to reduce stormwater peak flows and volumes and other impacts associated with land development. The following text discusses the low impact development BMPs outlined in the LID Manual with respect to the project. Italicized text is taken directly from the LID Manual and reproduced for this report. Portions of the italicized text are condensed from the LID Manual. Immediately following and written in regular text, will be the response as it applies to the project.

#### **Site Planning**

- *Project applicants must implement a holistic approach to site design in order to develop a more hydraulically-functional site, help to maximize the effectiveness of on-site retention, and integrate stormwater management throughout the project site. Early project site planning can identify physical site constraints, reduce costs of downstream stormwater quality control measures, and prevent potential project site re-design.*

Response:

The project site layout conforms to natural landforms.

**Protect and Restore Natural Areas**

- *Conservation of natural areas, soils, and vegetation helps to retain numerous functions of pre-development hydrology, including rainfall interception, infiltration, and evapotranspiration. Each project site possesses unique topographic, hydrologic, and vegetative features, some of which are more suitable for development than others. Sensitive areas, such as streams and their buffers, floodplains, wetlands, steep slopes, and highly-permeable soils, should be protected and/or restored. Slopes can be a major source of sediment and should be properly protected and stabilized. Locating development in less sensitive areas of a project site and conserving naturally vegetated areas can minimize environmental impacts from stormwater runoff.*

Response:

The site is currently developed, and therefore there is no opportunity to preserve existing natural vegetation. The proposed site will include new landscaping and new trees.

**Minimize Impervious Area**

- *The potential for discharge of pollutants in stormwater runoff from a project site increases as the percentage of impervious area within the project site increases because impervious areas increase the volume and rate of stormwater runoff. Pollutants deposited on impervious areas are easily mobilized and transported by stormwater runoff. Minimizing impervious area through site design is an important method to reducing the pollutant load in stormwater runoff. In addition to the environmental and aesthetic benefits, a highly pervious site may allow reduction of potential downstream conveyance and stormwater quality control measures, yielding savings in development costs. Minimizing impervious area will also reduce the stormwater runoff coefficient, which is directly proportional to the volume of stormwater runoff that must be retained on-site.*

Response:

The project incorporates landscaping/vegetated areas onsite to minimize the impervious footprint.

## 4.0 SOURCE CONTROL MEASURES

Source control measures are designed to prevent pollutants from contacting stormwater runoff or prevent discharge of contaminated stormwater runoff to the storm drain system and/or receiving water. This section describes structural type, source control measures that will be considered for implementation in conjunction with appropriate non-structural source control measures. The following text discusses the source control measures BMPs from the LID Manual with respect to the project. Italicized text is taken directly from the LID Manual, and reproduced for this report. Portions of the italicized text are condensed from the LID Manual. Immediately following and written in regular text, will be the response as it applies to the project. For more information regarding the Source Control Measures outlined below, see Appendix D from the LID Manual.

### **S-1: Storm Drain Message and Signage**

- *Signs with language and/or graphical icons that prohibit illegal dumping, must be posted at designated public access points along channels and streams within the project area. Consult with Los Angeles County Department of Public Works (LACDPW) staff to determine specific signage requirements for channels and streams.*
- *Storm drain message markers, placards, concrete stamps, or stenciled language/icons (e.g., "No Dumping – Drains to the Ocean") are required at all storm drain inlets and catch basins within the project area to discourage illegal or inadvertent dumping. Signs should be placed in clear sight facing anyone approaching the storm drain inlet or catch basin from either side (see Figure D-1 and Figure D-2). LACDPW staff should be contacted to determine specific requirements for types of signs and methods of application. A stencil can be purchased for a nominal fee from LACDPW Building and Safety Office by calling (626) 458-3171. All storm drain inlet and catch basin locations must be identified on the project site map.*

#### Response:

All catch basins with open grates within the project site will be stenciled.



### **S-2: Outdoor Material Storage**

- *Design specifications for material storage areas are regulated by local building and fire codes, ordinances, and zoning requirements. Source control measures presented in the LID Manual are intended to enhance and be consistent with local code and ordinance requirements while addressing stormwater runoff concerns. The design specifications, presented in Table D-2 in the LID Manual, must be incorporated into the design of outdoor material storage areas when stored materials could contribute pollutants to the storm drain system. The level of controls required varies relative to the risk category of the material stored.*

Response:

The project does not propose any outdoor material storage areas. If these conditions change, it is the responsibility of the project site owner/operator to ensure that outdoor materials storage will be designed pursuant to the guidelines outlined above and in the LID Manual.

### **S-3: Outdoor Trash Storage and Waste Handling Area**

- *Wastes from commercial and industrial sites are typically hauled away for disposal by either public or commercial carriers that may have design or access requirements for waste storage areas. Design specifications for waste handling areas are regulated by local building and fire codes and by current County ordinances and zoning requirements. The design specifications, listed below in Table D-3, are recommendations and are not intended to conflict with requirements established by the waste hauler. The design specifications are intended to enhance local codes and ordinances while addressing stormwater runoff concerns. The waste hauler should be contacted prior to the design of trash storage and collection areas to determine established and accepted guidelines for designing trash collection areas. All hazardous waste must be handled in accordance with the legal requirements established in Title 22 of the California Code of Regulations. Conflicts or issues should be discussed with LACDPW staff.*

Response:

The project site does propose storage areas for trash storage areas. Therefore, the outdoor trash storage area will be designed pursuant to the guidelines outlined above and in the LID Manual.

#### **S-4: Outdoor Loading/Unloading Dock Area**

- *Design specifications for outdoor loading/unloading dock areas are regulated by local building and fire codes and by current County ordinances and zoning requirements. Additionally, individual businesses may have their own design or access requirements for loading docks. Design specifications presented in this fact sheet are intended to enhance and be consistent with these code and ordinance requirements while addressing stormwater runoff concerns. The design specifications presented in Table D-4 are not intended to conflict with requirements established by individual businesses, but should be followed to the maximum extent practicable.*

Response:

The project does not propose any outdoor loading and unloading dock areas. If these conditions change, it is the responsibility of the project site owner/operator to ensure that outdoor materials storage will be designed pursuant to the guidelines outlined above and in the LID Manual.

#### **S-5: Outdoor Vehicle/Equipment Repair/Maintenance Area**

- *Design specifications for vehicle and equipment repair/maintenance areas are regulated by local building and fire codes and by current County ordinances and zoning requirements. The design specifications presented in this fact sheet are intended to enhance and be consistent with these code and ordinance requirements while addressing stormwater runoff concerns. The design specifications required for vehicle and equipment repair/maintenance areas are presented in Table D-5. All wash water and hazardous and toxic wastes must be prevented from entering the storm drain system.*

Response:

The project does not propose any outdoor vehicle equipment repair areas, or outdoor vehicle maintenance areas. If these conditions change, it is the responsibility of the project site owner/operator to ensure that outdoor materials storage will be designed pursuant to the guidelines outlined above and in the LID Manual.

#### **S-6: Outdoor Vehicle/Equipment/Accessory Washing Area**

- *Design specifications for vehicle/equipment/accessory washing areas are regulated by local building and fire codes and current County ordinances and zoning requirements. The design specifications presented in Table D-6 are intended to enhance and be consistent with these requirements while addressing stormwater runoff concerns. All wash water and hazardous and toxic wastes must be prevented from entering the storm drain system.*

Response:

The project does not propose any outdoor vehicle equipment areas or outdoor vehicle accessory washing areas. If these conditions change, it is the responsibility of the project site owner/operator to ensure that outdoor materials storage will be designed pursuant to the guidelines outlined above and in the LID Manual.

### **S-7: Fuel and Maintenance Area**

- *Design specifications for fuel and maintenance areas are regulated by local building and fire codes and current County ordinances and zoning requirements. The design specifications presented in Table D-7 are intended to enhance and be consistent with these code and ordinance requirements while addressing stormwater runoff concerns.*

Response:

The project does not propose any fuel and maintenance areas. If these conditions change, it is the responsibility of the project site owner/operator to ensure that outdoor materials storage will be designed pursuant to the guidelines outlined above and in the LID Manual.

### **S-8: Landscape Irrigation Practices**

- *Choose plants that minimize the need for fertilizer and pesticides.*
- *Group plants with similar water requirements and water accordingly.*
- *Use mulch to minimize evaporation and erosion.*
- *Include a vegetative boundary around project site to act as a filter.*
- *Design the irrigation system to only water areas that need it.*
- *Install an approved subsurface drip, pop-up, or other irrigation system. The irrigation system should employ effective energy dissipation and uniform flow spreading methods to prevent erosion and facilitate efficient dispersion.*
- *Install rain sensors to shut off the irrigation system during and after storm events.*
- *Include pressure sensors to shut off flow-through system in case of sudden pressure drop. A sudden pressure drop may indicate a broken irrigation head or water line.*
- *If the hydraulic conductivity in the soil is not sufficient for the necessary water application rate, implement soil amendments to avoid potential geotechnical hazards (i.e., liquefaction, landslide, collapsible soils, and expansive soils).*
- *For sites located on or within 50 feet of a steep slope (15% or greater), do not irrigate landscape within three days of a storm event to avoid potential geotechnical instability.*
- *Implement Integrated Pest Management practices*
- *For additional guidelines and requirements, refer to the Los Angeles County Department of Health Services.*

Response:

Irrigation practices and systems for the project will be designed pursuant to the guidelines shown above and in the LID Manual.

## **S-9: Building Material Selection**

### *Lumber*

- *Decks and other house components constructed using pressure-treated wood that is typically treated using arsenate, copper, and chromium compounds are hazardous to the environment. Pressure-treated wood may be replaced with cement-fiber or vinyl.*

### *Roofs, Fencing, and Metals*

- *Minimizing the use of copper and galvanized (zinc-coated) metals on buildings and fencing can reduce leaching of these pollutants into stormwater runoff. The following building materials are conventionally made of galvanized metals:*
  - *Metal roofs*
  - *Chain-link fencing and siding*
  - *Metal downspouts, vents, flashing, and trim on roofs.*

*Architectural use of copper for roofs and gutters should be avoided. As an alternative to copper and galvanized materials, coated metal products are available for both roofing and gutter application. Vinyl-coated fencing is an alternative to traditional galvanized chain-link fences. These products eliminate contact of bare metal with precipitation or stormwater runoff, and reduce the potential for stormwater runoff contamination. Roofing materials are also made of recycled rubber and plastic. Green roofs may be an option. Green roofs use vegetation such as grasses and other plants as an exterior surface. The plants reduce the velocity of stormwater runoff and absorb water to reduce the volume of stormwater runoff. One potential problem with using green roofs in the Los Angeles County area is the long, hot and dry summers, which may kill the plants if they are not watered. See the Green Roof Fact Sheet (RET- 7) in Appendix E of the LID Manual.*

### Response:

Building material selection will be designed pursuant to the guidelines outlined above and in the LID Manual.

### **S-10: Animal Care and Handling Facilities**

- *Site barns, corrals, and pastures on property that drains away from the storm drain system and receiving waters.*
- *Locate animal washing areas, pastures, horse riding areas, stalls, or cages at least 50 feet away from storm drains, domestic wells, septic tank or leach field sites, and receiving waters.*
- *Design berms, gutters, or grassed ditches to divert stormwater runoff away from animal area, storm drain system, and receiving waters.*
- *Cover animal enclosures (i.e., stables) to protect them from precipitation.*
- *Prevent animals from entering sensitive environmental areas.*
- *Regularly sweep or shovel animal holding areas.*

Response:

The project does not propose any animal care or handling facilities. If these conditions change, it is the responsibility of the project site owner/operator to ensure that outdoor materials storage will be designed pursuant to the guidelines outlined above and in the LID Manual.

### **S-11: Outdoor Horticulture Areas**

- *Do not allow wash water from the horticulture area to drain directly to the storm drain system or receiving waters*

Response:

The project does not propose outdoor horticulture areas. If these conditions change, it is the responsibility of the project site owner/operator to ensure that outdoor materials storage will be designed pursuant to the guidelines outlined above and in the LID Manual.

## 5.0 STORMWATER QUALITY DESIGN VOLUME CALCULATIONS

Current water quality requirements are based on treating a specific volume of stormwater runoff from the project site (stormwater quality design volume [SWQDv]). By treating the SWQDv, it is expected that pollutant loads, which are typically higher during the beginning of storm events, will be reduced or prevented from reaching the receiving waters.

### 5.1 DESIGN STORM EVENT

The design storm, for which the SWQDv is calculated, is defined as the greater of:

- *The 0.75-inch, 24-hour rain-event; or*
- *The 85<sup>th</sup> percentile, 24-hour rain event as determined from the Los Angeles County 85<sup>th</sup> percentile precipitation isoheytal map.*

It was determined that the 85<sup>th</sup> percentile, 24-hour rain event will be the design storm for which the SWQDv will be calculated for this project site as shown below.

The 85<sup>th</sup> percentile, 24-hour rain = 1.0-inch > 0.75-inches **[Use the 85<sup>th</sup> percentile]**

Note:

The 85<sup>th</sup> percentile, 24-hour rain event precipitation was found using the Los Angeles County Hydrology Map GIS Viewer, see **Appendix C**.

## **5.2 STORMWATER QUALITY DESIGN VOLUME (SWQDV)**

The project site was determined to be a Designated Project, therefore the project site is required to retain 100% of the SWQDV on-site or provide biotreatment for 1.5 times the SWQDV. The SWQDV for the site was calculated using the HydroCalc software developed by Los Angeles County Department of Public Works (LACDPW). The software completes the full MODRAT calculation process and produces the peak stormwater runoff flow rates and volumes for single subareas. HydroCalc is limited to watersheds and project areas up to 40 acres.

The SWQDV required to be treated is summarized below.

### **HydroCalc Analysis – 85<sup>TH</sup> Percentile Storm**

#### **DMA A**

<b>Input Parameters</b>	
Project Name	MT SAC Student Center
Subarea ID	DMA A
Area (ac)	1.81
Flow Path Length (ft)	345.0
Flow Path Slope (vft/hft)	0.065
85th Percentile Rainfall Depth (in)	1.0
Percent Impervious	0.9
Soil Type	2
Design Storm Frequency	85th percentile storm
Fire Factor	0
LID	True
<b>Output Results</b>	
Modeled (85th percentile storm) Rainfall Depth (in)	1.0
Peak Intensity (in/hr)	0.3677
Undeveloped Runoff Coefficient (Cu)	0.4938
Developed Runoff Coefficient (Cd)	0.8594
Time of Concentration (min)	14.0
Clear Peak Flow Rate (cfs)	0.572
Burned Peak Flow Rate (cfs)	0.572
24-Hr Clear Runoff Volume (ac-ft)	0.1232
24-Hr Clear Runoff Volume (cu-ft)	5367.219

**DMA B**

<b>Input Parameters</b>	
Project Name	MT SAC Student Center
Subarea ID	DMA B
Area (ac)	2.53
Flow Path Length (ft)	390.0
Flow Path Slope (vft/hft)	0.04
85th Percentile Rainfall Depth (in)	1.0
Percent Impervious	0.9
Soil Type	2
Design Storm Frequency	85th percentile storm
Fire Factor	0
LID	True
<b>Output Results</b>	
Modeled (85th percentile storm) Rainfall Depth (in)	1.0
Peak Intensity (in/hr)	0.3454
Undeveloped Runoff Coefficient (Cu)	0.4731
Developed Runoff Coefficient (Cd)	0.8573
Time of Concentration (min)	16.0
Clear Peak Flow Rate (cfs)	0.7491
Burned Peak Flow Rate (cfs)	0.7491
24-Hr Clear Runoff Volume (ac-ft)	0.1722
24-Hr Clear Runoff Volume (cu-ft)	7501.6966



## 6.0 STORMWATER QUALITY CONTROL MEASURES

Stormwater quality control measures are required to augment site design principles and source control measures to reduce the volume of stormwater runoff and potential pollution loads in stormwater runoff to the maximum extent practicable. Stormwater quality control measures are designed to handle the frequent, smaller storm events, or the initial volume of stormwater runoff from larger storm events (typically referred to as first flush events). The first flush of larger storm events is the initial period of the storm where stormwater runoff typically carries the highest concentration and loads of pollutants. Small, frequent storm events represent most of the total annual average precipitation in the County. The LID Ordinance requires that all Designated Projects retain the SWQDv on-site using retention-based stormwater quality control measures (infiltration and/or stormwater runoff harvest and use) or biofiltrate 1.5 times the SWQDv if infiltration is not feasible.

All the stormwater quality control measures outlined in the LID Manual were evaluated. It was determined that the most practicable treatment BMP for the project will be the following:

- (2) Underground Infiltration Vaults

### 6.1 UNDERGROUND INFILTRATION SIZING

Stormwater runoff is intercepted by a series of inlet drains within the surrounding landscaping as well as the roof downspouts and is conveyed through underground storm drain pipe into the underground infiltration vaults. The underground infiltration vaults are designed to infiltrate the SWQDv of 12,869 cf for the project site. Overflow for excess stormwater will be conveyed through an emergency outlet device in the underground infiltration system and into the existing storm drain to the south. Calculations for the infiltration vaults are available in **Appendix E**.

## 7.0 HYDROMODIFICATION

All Designated projects located within natural drainage systems that have not been improved or drainage systems that are tributary to a natural drainage system are required to implement hydromodification controls.

Projects may be exempt from implementation of hydromodification control measures where assessments of downstream channel conditions and proposed discharge hydrology indicate adverse hydromodification effects to beneficial uses of natural drainage systems are unlikely.

The proposed project has been determined to be **EXEMPT** from hydromodification requirements since it discharges to concrete-lined channels. Therefore the site does not have any adverse hydromodification impacts to natural drainage systems.

## 8.0 STORMWATER QUALITY CONTROL MEASURE MAINTENANCE

Continued effectiveness of stormwater quality control measures specified in the LID Standards Manual depends on on-going inspection and maintenance. All publicly maintained stormwater quality control measures must have easements for access and maintenance or be in lots dedicated to the County in fee title. To ensure that such maintenance is provided, LACDPW may require the submittal of a Maintenance Plan and execution of a Maintenance Agreement with the owner/operator of stormwater quality control measures. The property owner or his/her designee is responsible for complying with the Maintenance Agreement outlined in the LID Manual. A copy of the Maintenance Agreement is provided in **Appendix H**.

### 8.1 MAINTENANCE RESPONSIBILITY

The Owner of the project site is the site operator and will be the party responsible to ensure implementation and funding of maintenance of permanent BMPs.

It is anticipated that the owner of the project will manage multiple separate maintenance contracts for different types of maintenance (e.g., landscape maintenance vs. maintenance of the BMPs). Throughout this section, the owner of the project is the “party responsible to ensure implementation and funding of maintenance of permanent BMPs.” The party who actually performs the activities is the “inspector,” “maintenance contractor,” or “maintenance operator.”

### 8.2 INSPECTION AND MAINTENANCE FOR SOURCE CONTROL MEASURES

The following source control measures for the project requires permanent maintenance:

- Storm Drain Message and Signage
- Outdoor Trash Storage and Waste Handling
- Landscape Irrigation Practices

The discussions below provide inspection criteria, maintenance indicators, and maintenance activities for the above listed source control measures that require permanent maintenance.

### **S-1 Storm Drain Message and Signage**

Legibility and visibility of markers and signs should be maintained (e.g., signs should be repainted or replaced as necessary). If required by the City, the owner/operator or homeowner's association shall enter into a maintenance agreement with the agency or record deed restriction upon the property title to maintain the legibility of placards and signs.

### **S-3 Outdoor Trash Storage and Waste Handling Area**

The integrity of structural elements that are subject to damage (e.g., screens, covers, signs) must be maintained by the owner/operator as required by local codes and ordinances. Outdoor trash storage and waste handling areas must be checked periodically to ensure containment of accumulated water and prevention of stormwater run-on. Maintenance agreements between the City and the owner/operator may be required. Failure to properly maintain building and property may subject the property owner to citation.

### **S-8 Landscape Irrigation Practices**

Maintain irrigation areas to remove trash and debris and loose vegetation. Rehabilitate areas of bare soil. If a rain or pressure sensor is installed, it should be checked periodically to ensure proper function. Inspect and maintain irrigation equipment and components to ensure proper functionality. Clean equipment as necessary to prevent algae growth and vector breeding. Failure to properly maintain building and property may subject the property owner to citation.

## **8.3 INSPECTION AND MAINTENANCE FOR STORM QUALITY MEASURES**

The following storm quality measure for the project requires permanent maintenance:

- Underground Infiltration System

The discussions below provide inspection criteria, maintenance indicators, and maintenance activities for the above listed storm quality measure that require permanent maintenance according to manufacturer recommendations. These proprietary systems shall be inspected and maintained per manufacturer specifications and recommendations. See **Appendix G** for the Operations and Maintenance of each BMP listed above.

## **8.4 INSPECTION AND MAINTENANCE FREQUENCY**

The Table below lists the BMPs to be inspected and maintained and the minimum frequency of inspection and maintenance activities.

<b>BMP</b>	<b>Inspection Frequency</b>	<b>Maintenance Frequency</b>
Storm Drain Message and Signage	Monthly	Routine maintenance of marker and sign legibility and visibility. See Section 8.2.
Outdoor Trash Storage and Waste Handling	Monthly	Routine maintenance of structure and waste water within the trash area. See Section 8.2.
Landscape Irrigation Practices	Monthly	Routine trimming and trash removal; monthly non-routine maintenance as-needed based on maintenance indicators in Section 8.2.
Underground Infiltration System	Annual and after major storm events	Routine maintenance to clean the underground infiltration system of sediments, trash, and debris. As-needed maintenance based on maintenance indicators as outlined in <b>Appendix G</b> .

The frequencies given in the Summary Table of Inspection and Maintenance Frequency are minimum recommended frequencies for inspection and maintenance activities for the project. Typically, the frequency of maintenance required for permanent BMPs is site and drainage area specific. If it is determined during the regularly scheduled inspection and/or routine maintenance that a BMP requires more frequent maintenance (e.g., to remove accumulated trash) it may be necessary to increase the frequency of inspection and/or routine maintenance. If it is determined during the regularly scheduled inspection that the maintenance thresholds are consistently met or exceeded, it may be necessary to increase the frequency of inspection and routine maintenance.

## **8.5 RECORD KEEPING REQUIREMENTS**

The party responsible to ensure implementation and funding of maintenance of permanent BMPs shall maintain records documenting the inspection and maintenance activities. The records must be kept a minimum of 5 years and shall be made available to the City of Walnut for inspection upon request at any time.

## 9.0 SUMMARY

This Low Impact Development Report (LID) summarizes the permanent storm water management features proposed for the project site that will collectively meet the requirements set forth in the LID Manual. The project meets the hydromodification exemption criteria and is not required to implement hydromodification management facilities as discussed in Section 7.0 of this report.

The project is a "Designated Project," based on the LID Manual as discussed in Section 2.1.

Based on the "anticipated" pollutants of concern that may be generated on-site and identification of receiving waters that are listed as impaired on the 2010 CWA Section 303(d) List of Water Quality Limited Segments, the following are the project pollutants of concern: Ammonia, Coliform Bacteria, pH, Total Dissolved Solids, and Toxicity as outlined in Section 3.3 of this report.

In addition to treatment control BMPs, the project will incorporate source control BMPs which are described in Section 4.0 and Section 6.0.

The project includes a proposed network of storm water management features that will utilize source control measures to meet the requirements for stormwater quality design measure. The following list provides a summary of stormwater quality design measures selected for the project site:

- (2) underground infiltration vaults

The above stormwater quality design measure was selected for the project and provide "High" removal efficiency for the targeted pollutants of concern as discussed in Section 3.3 and Section 6.1.

The stormwater quality design measure maintenance in Section 8.0 of this report provides inspection criteria, maintenance indicators, and maintenance activities for the above-listed BMPs that require permanent maintenance.

This report accompanies a set of construction drawings and specifications which detail the construction, operation, and maintenance of the proposed Low Impact Development (LID) design elements for this site.

## **APPENDIX A**

---

### **VICINITY MAP**

# Vicinity Map

For

## Mt SAC Student Center

N. Grand Ave  
Walnut, CA 91789



## **APPENDIX B**

---

### **BMP SITE PLAN**



#	DATE	SUBMITTALS
	08/20/18	FINAL DD SUBMITTAL

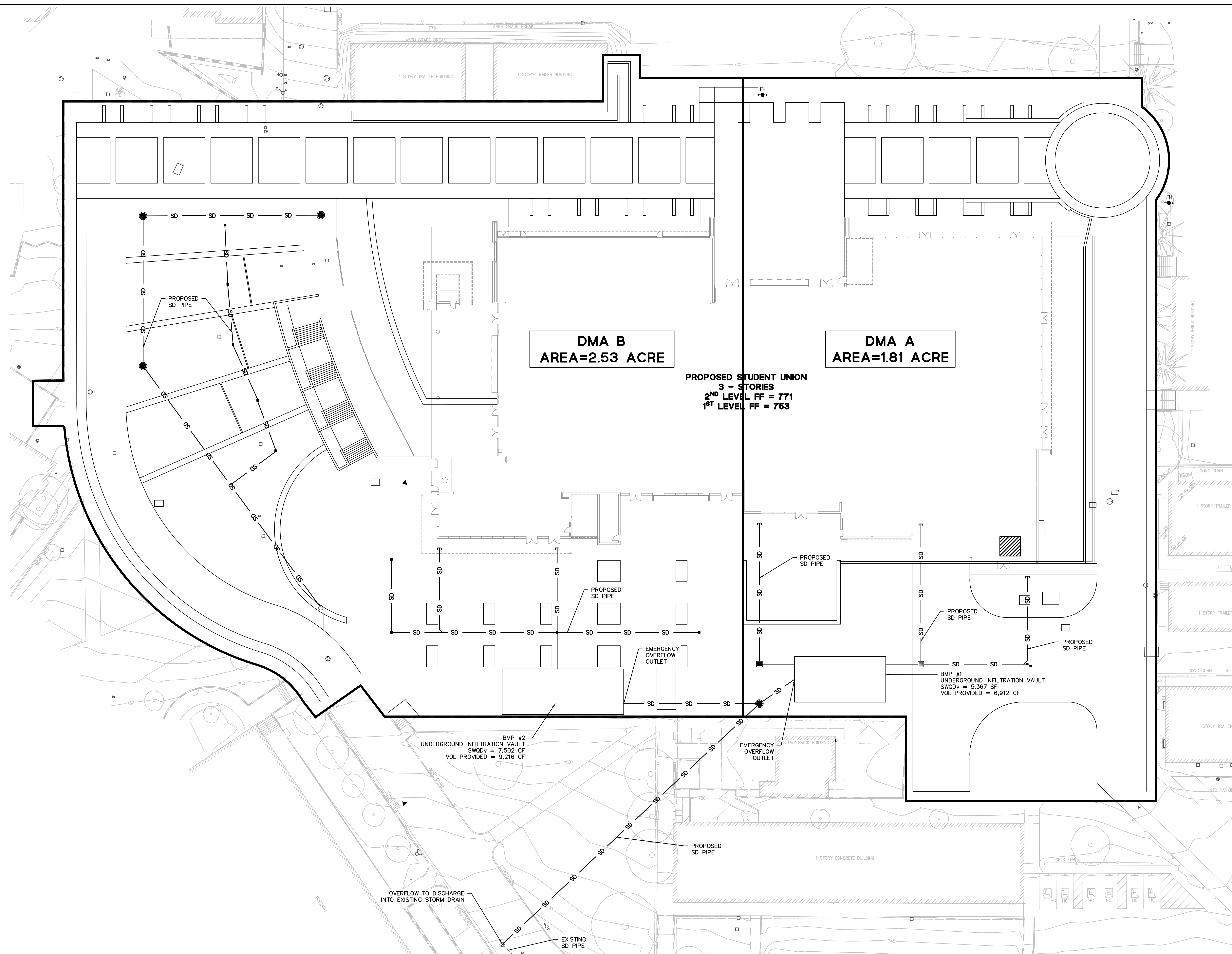

DRAINAGE MANAGEMENT AREA	AREA (ACRES)	LID BMP USED	V <sub>u</sub> (CU-FT)	VOL PROVIDED (CU-FT)
DMA A	1.81	UNDERGROUND INFILTRATION VAULT (BMP#1)	5,367	6,192
DMA B	2.53	UNDERGROUND INFILTRATION VAULT (BMP#2)	7,502	9,216
TOTAL	4.34		12,869	15,408

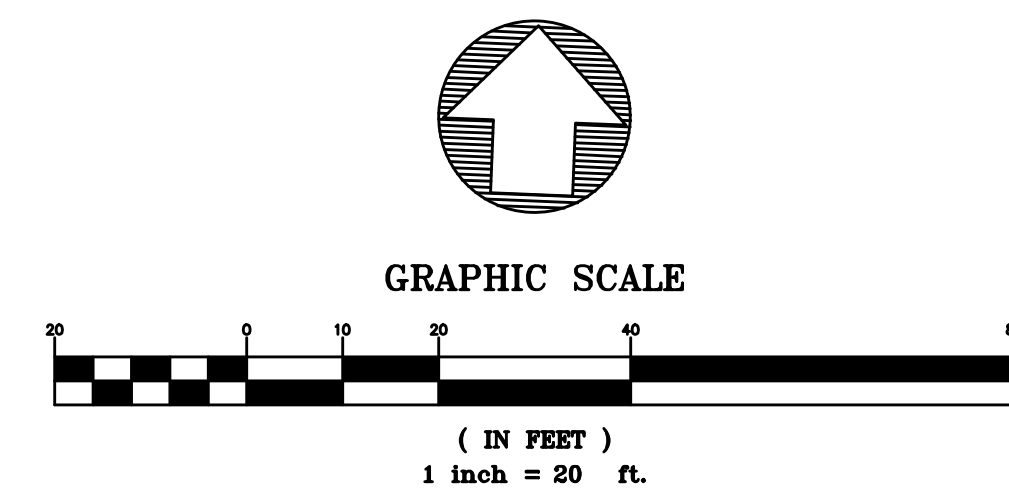

## **APPENDIX C**

### **COUNTY OF LOS ANGELES HYDROLOGY MAPS**

---





### Hydrology Map

A GIS viewer application to view the data for the hydrology manual.

LAYERS

- 50yr Two Tenths (Rainfall)
- DPA Zones
- Soils 2004
- Final 85th Percentile, 24-hr Rainfall
- Final 95th Percentile, 24-hr Rainfall
- 1-year, 1-hour Rainfall Intensity

SEARCH

Enter Address, Cross Street, or Parcel No.:  
(ex: 900 S. Fremont Ave., Fremont@Valley,  
5342005904)

Search

Address Search Results:

[mt sac](#)

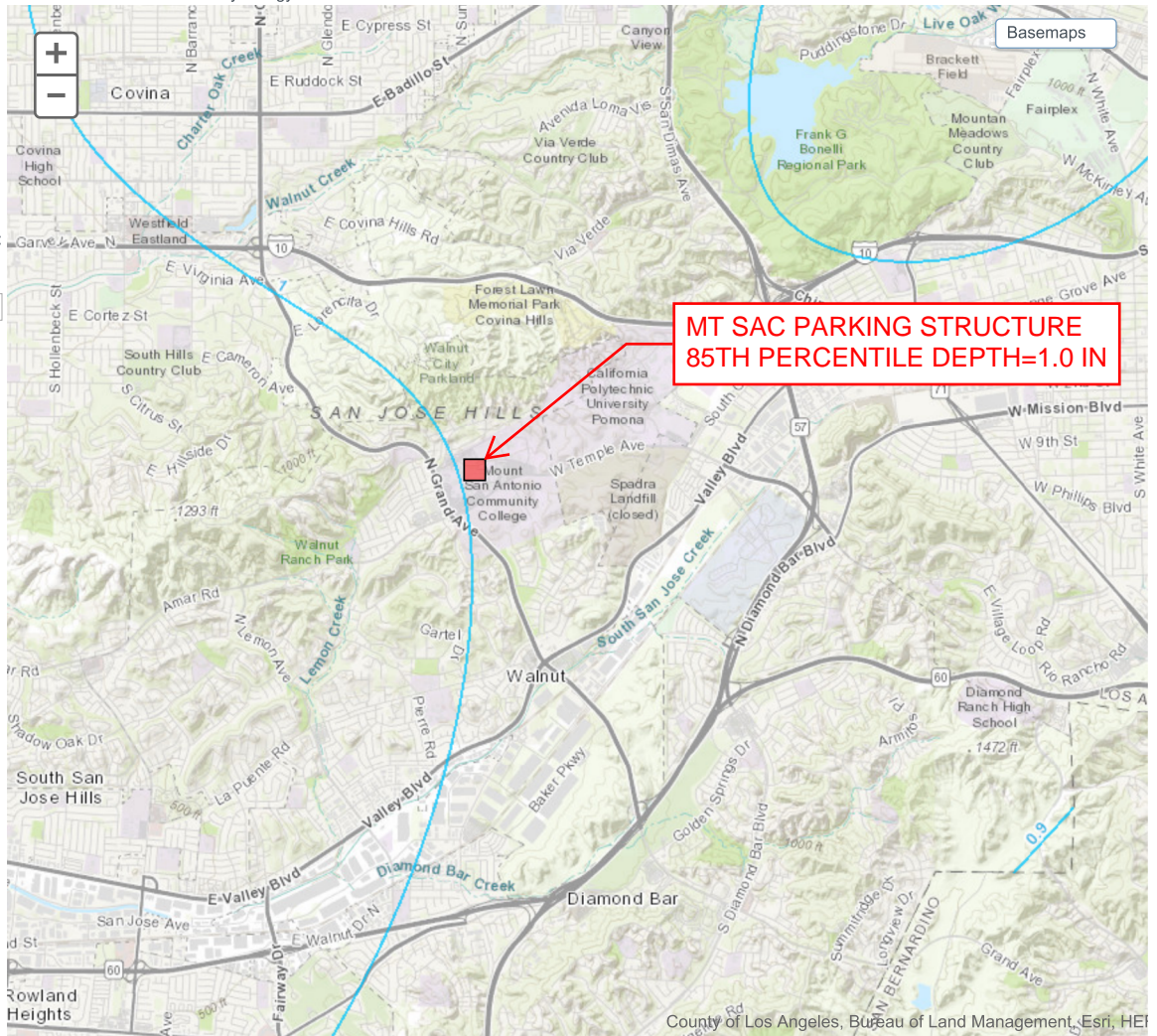

Map Tips



### Hydrology Map

A GIS viewer application to view the data for the hydrology manual.

#### LAYERS

- 50yr Two Tenths (Rainfall)
- DPA Zones
- Soils 2004
- Final 85th Percentile, 24-hr Rainfall
- Final 95th Percentile, 24-hr Rainfall
- 1-year, 1-hour Rainfall Intensity

#### SEARCH

Enter Address, Cross Street, or Parcel No.:

(ex: 900 S. Fremont Ave., Fremont@Valley, 5342005904)

**w temple ave and service rd, walnut**

Search

Address Search Results:

**w temple ave and service rd walnut**

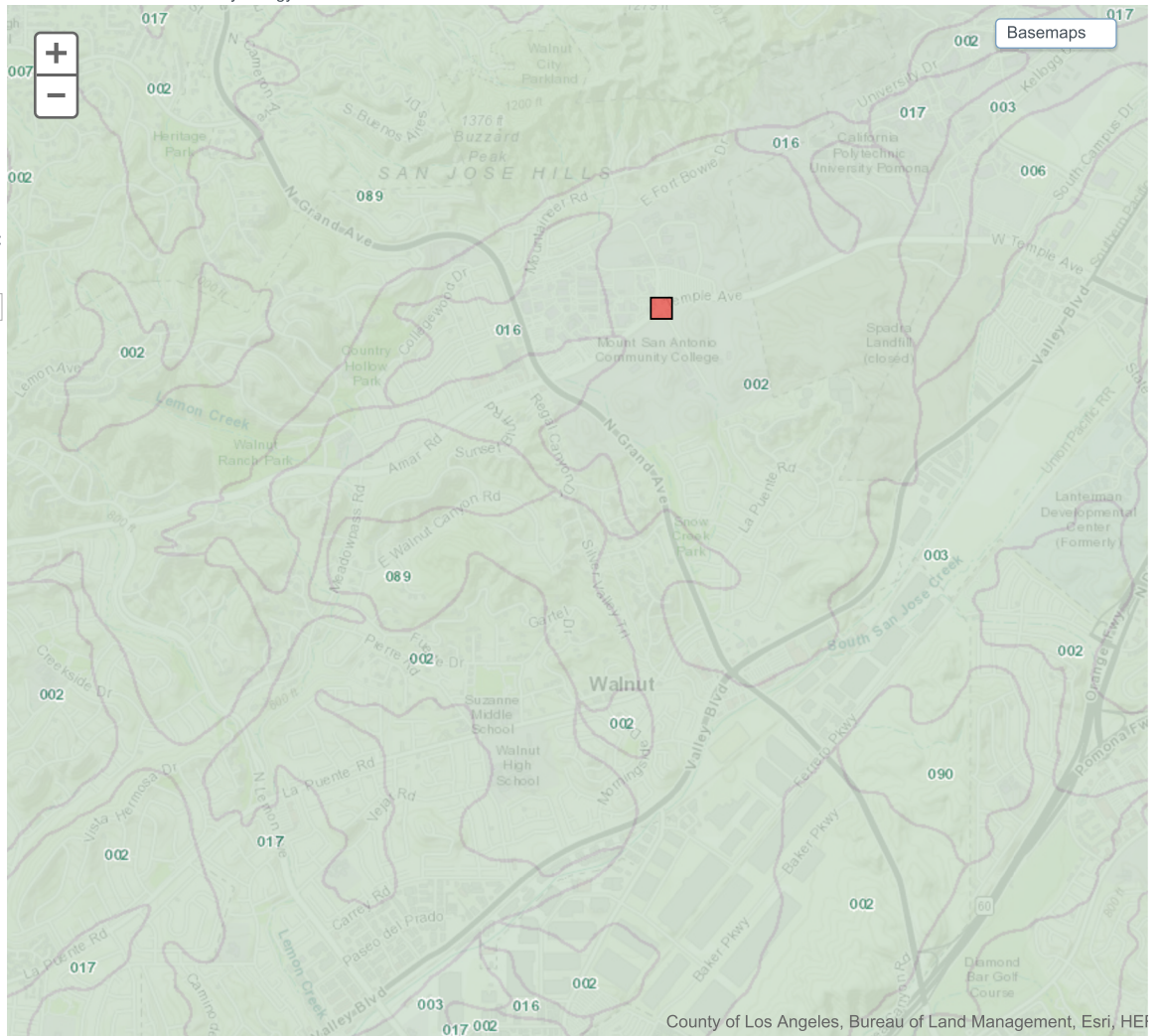

Map Tips

## **APPENDIX D**

### **HYDROCALC OUTPUT - 85<sup>TH</sup> PERCENTILE STORM**

---

# Peak Flow Hydrologic Analysis

File location: C:/Users/chas/Desktop/MT SAC Student Center - DMA A.pdf  
Version: HydroCalc 1.0.3

## Input Parameters

Project Name	MT SAC Student Center
Subarea ID	DMA A
Area (ac)	1.81
Flow Path Length (ft)	345.0
Flow Path Slope (vft/hft)	0.065
85th Percentile Rainfall Depth (in)	1.0
Percent Impervious	0.9
Soil Type	2
Design Storm Frequency	85th percentile storm
Fire Factor	0
LID	True

## Output Results

Modeled (85th percentile storm) Rainfall Depth (in)	1.0
Peak Intensity (in/hr)	0.3677
Undeveloped Runoff Coefficient (Cu)	0.4938
Developed Runoff Coefficient (Cd)	0.8594
Time of Concentration (min)	14.0
Clear Peak Flow Rate (cfs)	0.572
Burned Peak Flow Rate (cfs)	0.572
24-Hr Clear Runoff Volume (ac-ft)	0.1232
24-Hr Clear Runoff Volume (cu-ft)	5367.219

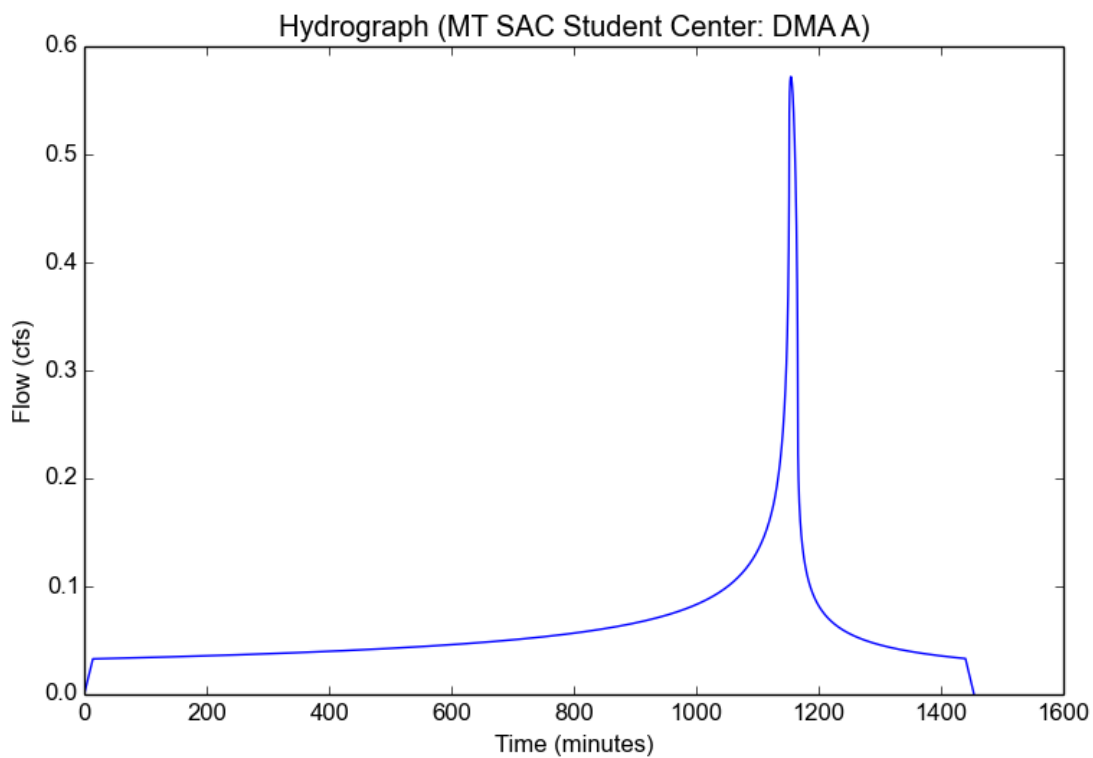

# Peak Flow Hydrologic Analysis

File location: C:/Users/chas/Desktop/MT SAC Student Center - DMA B.pdf  
Version: HydroCalc 1.0.3

## Input Parameters

Project Name	MT SAC Student Center
Subarea ID	DMA B
Area (ac)	2.53
Flow Path Length (ft)	390.0
Flow Path Slope (vft/hft)	0.04
85th Percentile Rainfall Depth (in)	1.0
Percent Impervious	0.9
Soil Type	2
Design Storm Frequency	85th percentile storm
Fire Factor	0
LID	True

## Output Results

Modeled (85th percentile storm) Rainfall Depth (in)	1.0
Peak Intensity (in/hr)	0.3454
Undeveloped Runoff Coefficient (Cu)	0.4731
Developed Runoff Coefficient (Cd)	0.8573
Time of Concentration (min)	16.0
Clear Peak Flow Rate (cfs)	0.7491
Burned Peak Flow Rate (cfs)	0.7491
24-Hr Clear Runoff Volume (ac-ft)	0.1722
24-Hr Clear Runoff Volume (cu-ft)	7501.6966

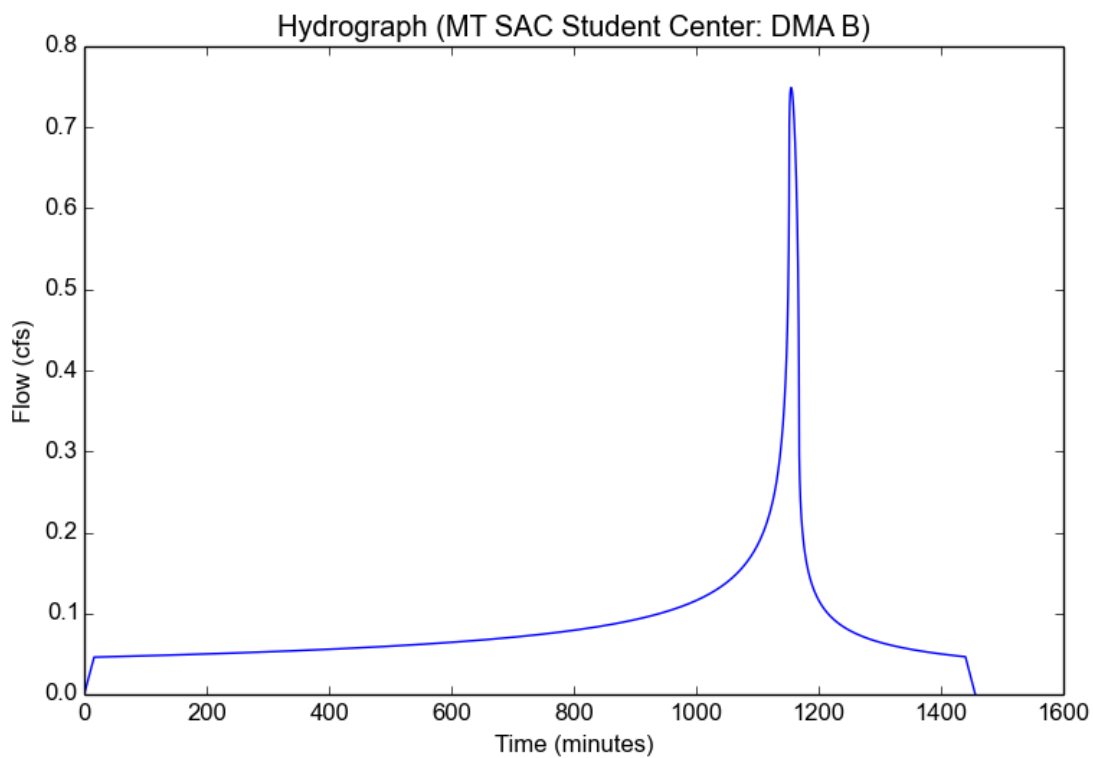



## **APPENDIX E**

---

# STORMWATER QUALITY DESIGN MEASURE CALCULATIONS



## **APPENDIX F**

### **BMP FACT SHEETS**

---

## GENERAL NOTES:

THE STORM CAPTURE™ SYSTEM BY OLDCASTLE PRECAST IS PART OF THE STORMWATER MANAGEMENT SYSTEM FOR THE RESPECTIVE SITE, AS PREPARED BY THE PROJECT DESIGN ENGINEER. IT IS THE RESPONSIBILITY OF THE DESIGN ENGINEER TO DETERMINE DESIGN FLOW RATES, PRE-TREATMENT AND POST-TREATMENT REQUIREMENTS, STORAGE VOLUME, AND ENSURE THE FINAL DESIGN MEETS ALL CONVEYANCE AND STORAGE REQUIREMENTS. SYSTEM DESIGN AND TYPE, SOIL ANALYSIS, LOADING REQUIREMENTS, COVER HEIGHT AND MODULE SIZE DETERMINE THE FOUNDATION TYPE AND REQUIREMENTS AS STATED HEREIN. ANY VARIATIONS FOUND DURING CONSTRUCTION FROM THE SITE AND SYSTEM ANALYSIS MUST BE REPORTED TO THE PROJECT DESIGN ENGINEER. THE PROJECT DESIGN ENGINEER IS RESPONSIBLE FOR OBTAINING A GEOTECHNICAL ENGINEERING REPORT VERIFYING THE BEARING CAPACITY STATED IN DESIGN NOTES.

## DESIGN NOTES:

- DESIGN LOADINGS:
  - AASHTO HS20-44 W/ IMPACT.
  - DEPTH OF COVER = 6" - 5'-0".
  - ASSUMED WATER TABLE = BELOW BOTTOM.
  - EQUIVALENT FLUID PRESSURE = 45 PCF.
  - LATERAL LIVE LOAD SURCHARGE = 80 PSF.
  - NO LATERAL SURCHARGE FROM ADJACENT STRUCTURES.
- CONCRETE 28 DAY COMPRESSIVE STRENGTH SHALL BE 6,000 PSI.
- STEEL REINFORCEMENT: REBAR, ASTM A-615, GRADE 60.
- CEMENT: ASTM C-150 SPECIFICATION.
- STORM CAPTURE MODULE TYPE = INFILTRATION.
- DEPTH OF AGGREGATE BEARING LAYER TO BE DETERMINED IN ACCORDANCE WITH OLDCASTLE TECH NOTE SC-01.
- ALLOWABLE SOIL BEARING PRESSURE ADDRESSED IN OLDCASTLE TECH NOTE SC-01.
- REFERENCE STANDARDS:
  - ASTM C 890
  - ASTM C 891
  - ASTM C 913
- LESS THAN 6" OR GREATER THAN 5' OF COVER REQUIRES CUSTOM STRUCTURAL DESIGN AND MAY REQUIRE THICKER AGGREGATE BEARING LAYER.

## INSTALLATION NOTES:

THE STORM CAPTURE™ MODULE SYSTEM IS TO BE INSTALLED IN ACCORDANCE WITH ASTM C891, INSTALLATION OF UNDERGROUND PRECAST UTILITY STRUCTURES. PROJECT PLAN AND SPECIFICATIONS MUST BE FOLLOWED ALONG WITH ANY APPLICABLE REGULATIONS.

- PLAN LINE, GRADE AND ELEVATIONS MUST BE FOLLOWED.
- WHERE SPECIFIED, AN 8 OZ. NON-WOVEN GEOTEXTILE FABRIC MUST BE USED AS A SEPARATION LAYER AROUND THE STORM CAPTURE SYSTEM.
- PENETRATIONS IN THE GEOTEXTILE MAY ONLY BE MADE WITH SMOOTH WALL PIPES. MAKE PENETRATIONS FOR ALL OUTLETS BEFORE MAKING PENETRATIONS FOR ANY INLETS.
- THE AGGREGATE BEARING LAYER SHOULD CONSIST OF CLEAN, DURABLE CRUSHED AGGREGATE COMPACTED AS DIRECTED BY THE ENGINEER. OLDCASTLE RECOMMENDS MATERIALS SUCH AS NO. 56 OR NO. 57 STONE PER ASTM C33.
- DESIGNATED EMBEDDED LIFTERS MUST BE USED. USE PROPER RIGGING TO ASSURE ALL LIFTERS ARE EQUALLY ENGAGED WITH A MINIMUM 60 DEGREE ANGLE ON SLINGS AS NOTED AND IN ACCORDANCE WITH OLDCASTLE LIFTING PROCEDURES.
- MODULES MUST BE PLACED AS CLOSE TOGETHER AS POSSIBLE, AND GAPS SHALL NOT BE GREATER THAN 3/4". ALL EXTERIOR SYSTEM JOINTS SHALL BE COVERED WITH A MIN. 8" JOINT WRAP ON SIDES AND TOP (CS-212 CONSEAL OR EQUIVALENT). INSTALL ONE ROW CS-102 CONSEAL (OR EQUIVALENT) BETWEEN PRECAST PIECES.
- AUTHORIZATION SHOULD BE GIVEN BY THE PROJECT ENGINEER OR DESIGNATED PERSON PRIOR TO PLACEMENT ON BACKFILL FOR THE SYSTEM. CARE SHOULD BE TAKEN DURING PLACEMENT OF BACKFILL NOT TO DISPLACE MODULES OR JOINT WRAP. BACKFILL SHALL BE COMPACTED TO 95% STANDARD PROCTOR DENSITY OR AS SPECIFIED, AND SHOULD NOT BE COMPACTED WITHIN 6" OF MODULE.
- CONSTRUCTION EQUIPMENT EXCEEDING DESIGN LOADING SHALL NOT BE ALLOWED ON STRUCTURE.

## SPLASH PADS, INLETS AND RISERS:

PLACE SPLASH PADS AS DESIGNATED TO PREVENT SCOUR FROM INLETS AND INLET PIPES. ALL PIPE INLETS SHALL EXTEND INSIDE MODULE A MINIMUM OF 4". PLACE A NON-SHRINK, NON-METALIC GROUT, MIN. 3,000 PSI IN ANNULAR SPACE TO ELIMINATE ALL VOIDS.

## TABLE OF CONTENTS

NOTES & GENERAL ISO	1
TYPICAL ELEVATION	2
EXTERIOR DETAILS	3
INTERIOR DETAILS	4

NOTE: THIS VIEW IS FOR ILLUSTRATION PURPOSES ONLY TO SHOW FEATURES OF THE SYSTEM. ACTUAL LAYOUT VARIES BY PROJECT, SEE SITE PLAN LAYOUT. ALL PERIMETER WALLS ARE SOLID.

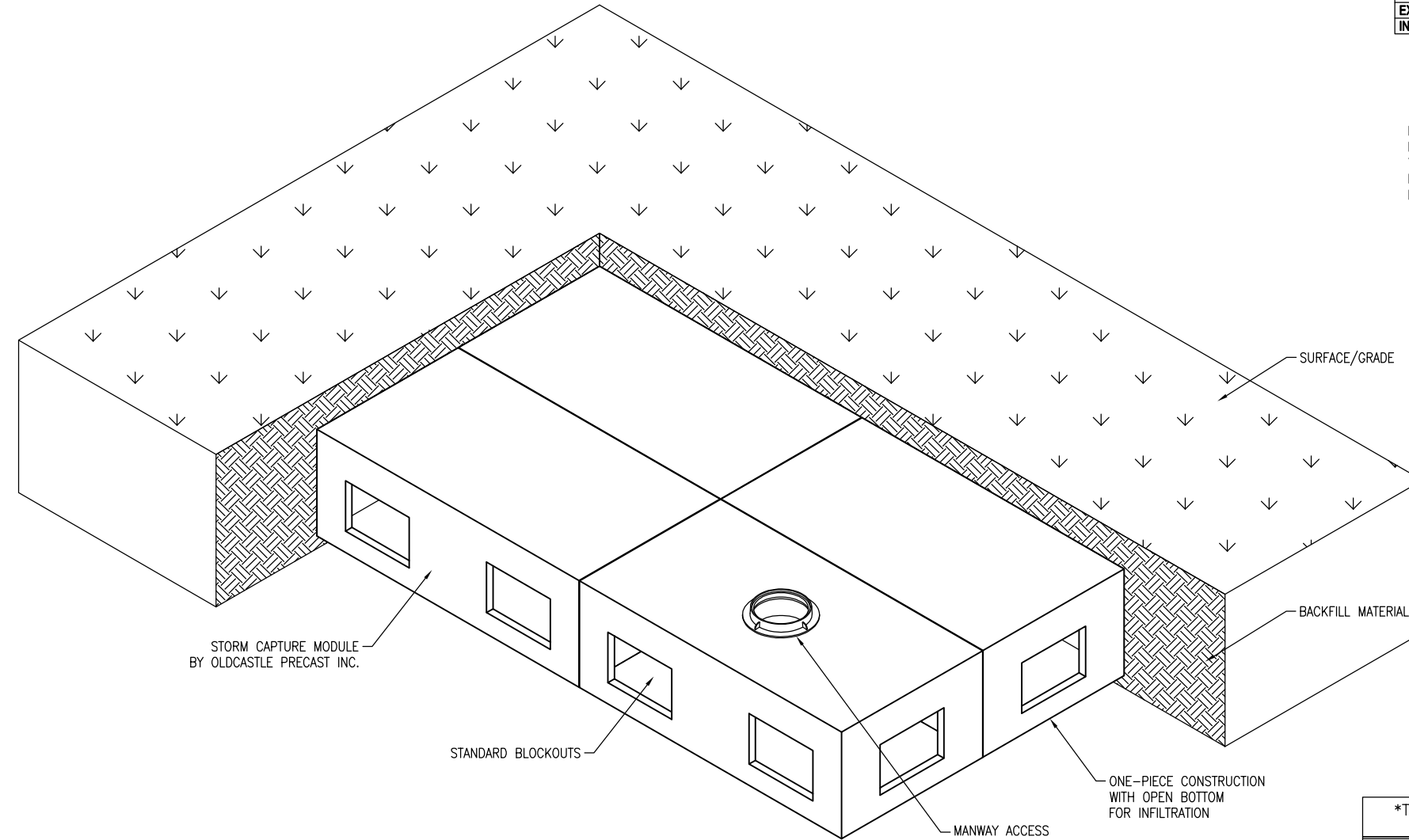

**INFILTRATION MODULE ISO VIEW**

N.T.S.

\*THIS MUST BE FILLED OUT BEFORE MANUFACTURING BEGINS\*

APPROVED W/ NO EXCEPTIONS TAKEN:   
 APPROVED AS NOTED:   
 REVISE AND RESUBMIT:

**- PRELIMINARY -  
NOT FOR CONSTRUCTION**

SIGNATURE \_\_\_\_\_ DATE \_\_\_\_\_



THIS DOCUMENT IS THE PROPERTY OF OLDCASTLE PRECAST, INC. IT IS CONFIDENTIAL, SUBMITTED FOR REFERENCE PURPOSES ONLY, AND SHALL NOT BE USED IN ANY WAY INJURIOUS TO THE INTERESTS OF, OR WITHOUT THE WRITTEN PERMISSION OF OLDCASTLE PRECAST, INC. COPYRIGHT ©2016 OLDCASTLE PRECAST, INC. ALL RIGHTS RESERVED.

**STORMCAPTURE**  
NOTES & GENERAL ISO

CUSTOMER \_\_\_\_\_

DATE	SALES STS	DRAWN STS	ENGINEER JH	CHECKED	SALES ORDER
DRAWING NUMBER SC - 6 ft top-only				REVISION REV DATE	SHEET 1 OF 4

## REVISIONS

REVISION	DATE	SHEETS	DESCRIPTION OF REVISION

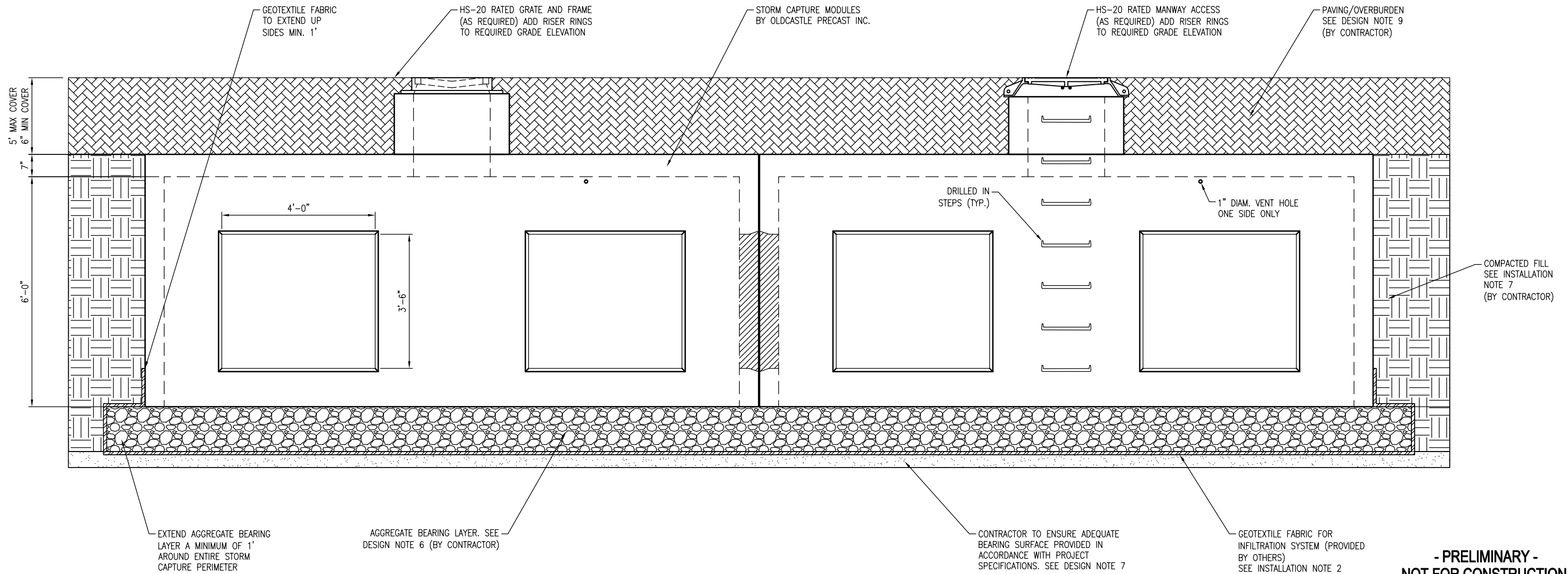

**TYPICAL ELEVATION**  
SCALE: 3/8" = 1'-0"

NOTE:  
FOR INFILTRATION - EXFILTRATION SYSTEMS, THE AGGREGATE SUBGRADE MUST BE WASHED AND CLEAN.

**- PRELIMINARY -  
NOT FOR CONSTRUCTION**



7921 SOUTH PARK PLAZA, SUITE 200, LITTLETON, CO 80120  
PHONE: 1-888-985-3227 FAX: 303-794-7497

THIS DOCUMENT IS THE PROPERTY OF OLDCASTLE PRECAST, INC. IT IS CONFIDENTIAL, SUBMITTED FOR REFERENCE PURPOSES ONLY, AND SHALL NOT BE USED IN ANY WAY INJURIOUS TO THE INTERESTS OF, OR WITHOUT THE WRITTEN PERMISSION OF OLDCASTLE PRECAST, INC. COPYRIGHT ©2016 OLDCASTLE PRECAST, INC ALL RIGHTS RESERVED

**STORMCAPTURE**  
TYPICAL ELEVATION

CUSTOMER

DATE	SALES STS	DRAWN STS	ENGINEER JH	CHECKED	SALES ORDER

DRAWING NUMBER: SC - 6 ft top-only

REVISION: REV DATE

SHEET: 2 OF 4

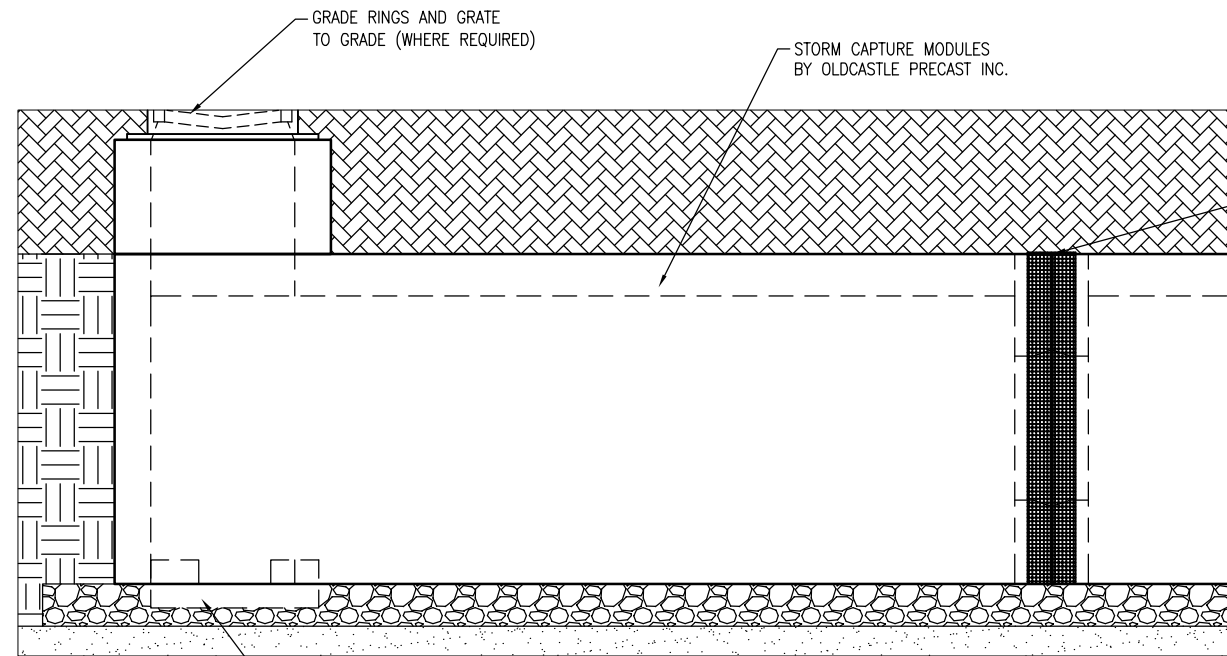

SPLASH PADS REQUIRED AT ALL PIPE AND GRATE INLETS. INVERT FLUSH WITH BOTTOM. SEE SPLASH PAD DETAIL ON NEXT PAGE

**GRATE INLET DETAIL**  
SCALE: 3/8" = 1'-0"

NOTE: WEIR PLATES, IF REQUIRED, MAY BE INSTALLED WITH RED-HEAD ANCHORS (BY OTHERS). ELEVATIONS TO BE DETERMINED BY PROJECT DESIGN ENGINEER

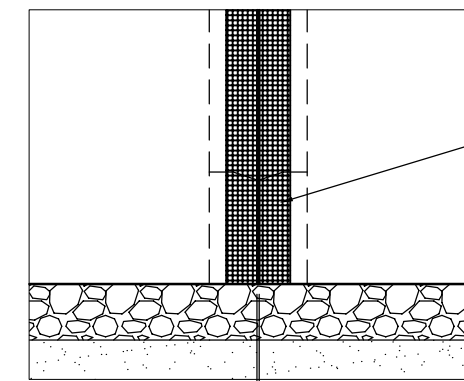

8" MIN. WIDE STRIP OF SELF-ADHESIVE OVER ENTIRE JOINT. PROVIDE MIN. 1' OVERLAP WHEN CONNECTING STRIPS. JOINT WRAP SUPPLIED BY OLDCASTLE AND INSTALLED BY OTHERS. SEE INSTALLATION NOTE 6.

1/4" GAP TYP. (3/4" MAX) BETWEEN STRUCTURES

**MODULE JOINT DETAIL**  
SCALE: 1/2" = 1'-0"

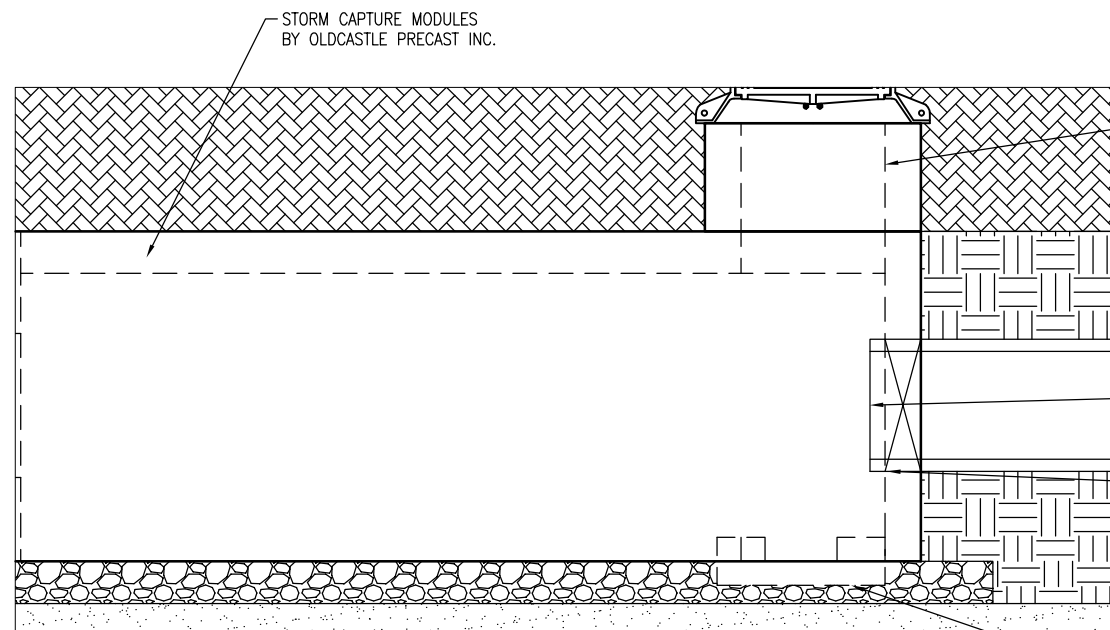

MIN. 30" MANWAY ACCESS PROVIDED FOR EACH MAINTENANCE MODULE

PIPE ENTRANCE AS REQUIRED

VOID SPACE TO BE GROUT FILLED BY CONTRACTOR IN-FIELD

**MANWAY ACCESS DETAIL**  
SCALE: 3/8" = 1'-0"

SPLASH PADS REQUIRED AT ALL PIPE AND GRATE INLETS. INVERT FLUSH WITH BOTTOM. SEE SPLASH PAD DETAIL ON NEXT PAGE

- PRELIMINARY -  
NOT FOR CONSTRUCTION



THIS DOCUMENT IS THE PROPERTY OF OLDCASTLE PRECAST, INC. IT IS CONFIDENTIAL, SUBMITTED FOR REFERENCE PURPOSES ONLY, AND SHALL NOT BE USED IN ANY WAY INJURIOUS TO THE INTERESTS OF, OR WITHOUT THE WRITTEN PERMISSION OF OLDCASTLE PRECAST, INC. COPYRIGHT ©2018 OLDCASTLE PRECAST, INC ALL RIGHTS RESERVED

**STORMCAPTURE**  
EXTERIOR DETAILS

CUSTOMER

DATE	SALES STS	DRAWN STS	ENGINEER JH	CHECKED	SALES ORDER
DRAWING NUMBER				REVISION	SHEET
SC - 6 ft top-only				REV DATE	3 OF 4

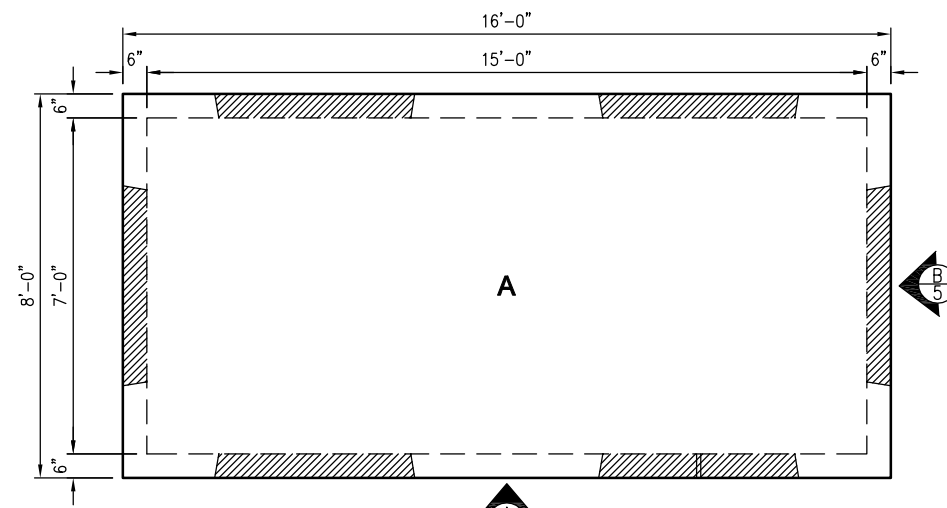

**STORM CAPTURE PLAN VIEW**  
SCALE: 1/4" = 1'-0"

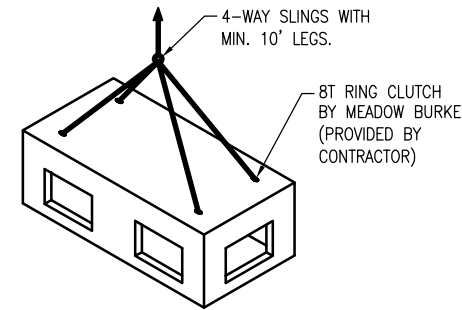

**MODULE LIFTING DETAIL**  
N.T.S.

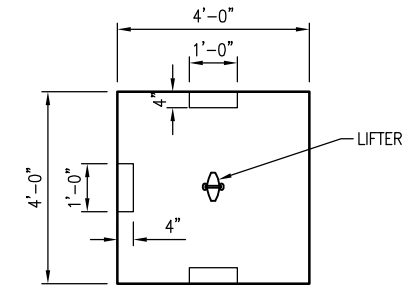

**SPLASH PAD - PLAN**  
SCALE: 1/4" = 1'-0"

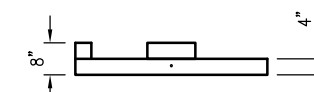

**SPLASH PAD - PROFILE**  
SCALE: 1/4" = 1'-0"

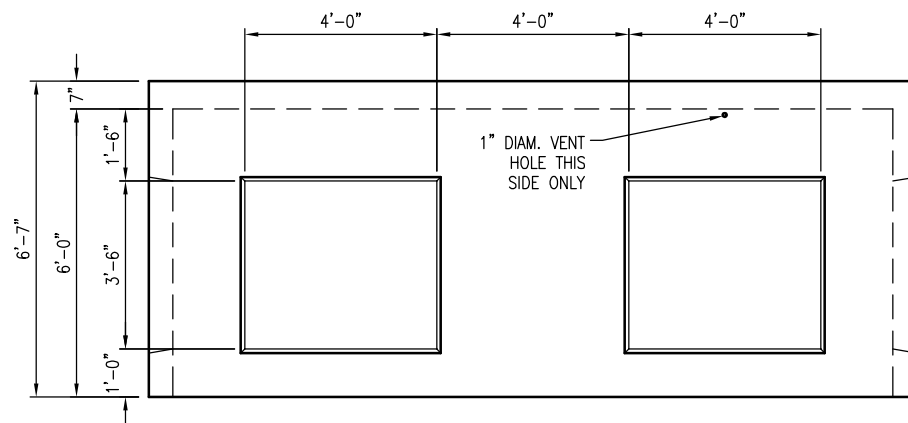

**VIEW A**  
SCALE: 1/4" = 1'-0"

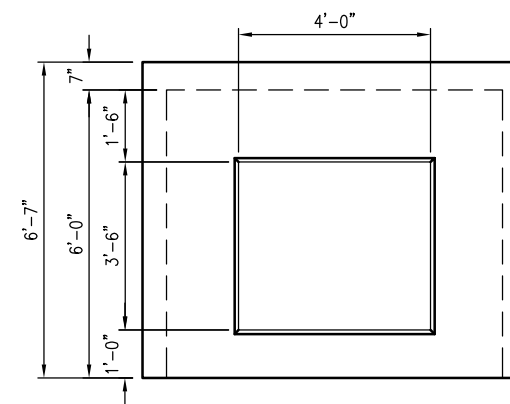

**VIEW B**  
SCALE: 1/4" = 1'-0"

- PRELIMINARY -  
NOT FOR CONSTRUCTION



THIS DOCUMENT IS THE PROPERTY OF OLDCASTLE PRECAST, INC. IT IS CONFIDENTIAL, SUBMITTED FOR REFERENCE PURPOSES ONLY, AND SHALL NOT BE USED IN ANY WAY INJURIOUS TO THE INTERESTS OF, OR WITHOUT THE WRITTEN PERMISSION OF OLDCASTLE PRECAST, INC. COPYRIGHT ©2018 OLDCASTLE PRECAST, INC. ALL RIGHTS RESERVED.

**STORMCAPTURE**  
INTERIOR DETAILS

CUSTOMER					
DATE	SALES STS	DRAWN STS	ENGINEER JH	CHECKED	SALES ORDER
DRAWING NUMBER				REVISION	SHEET
SC - 6 ft top-only				REV DATE	4 OF 4

## **APPENDIX G**

### **BMP OPERATIONS & MAINTENANCE MANUAL**

---



# STORMCAPTURE®

---

## Inspection and Maintenance Guide

---

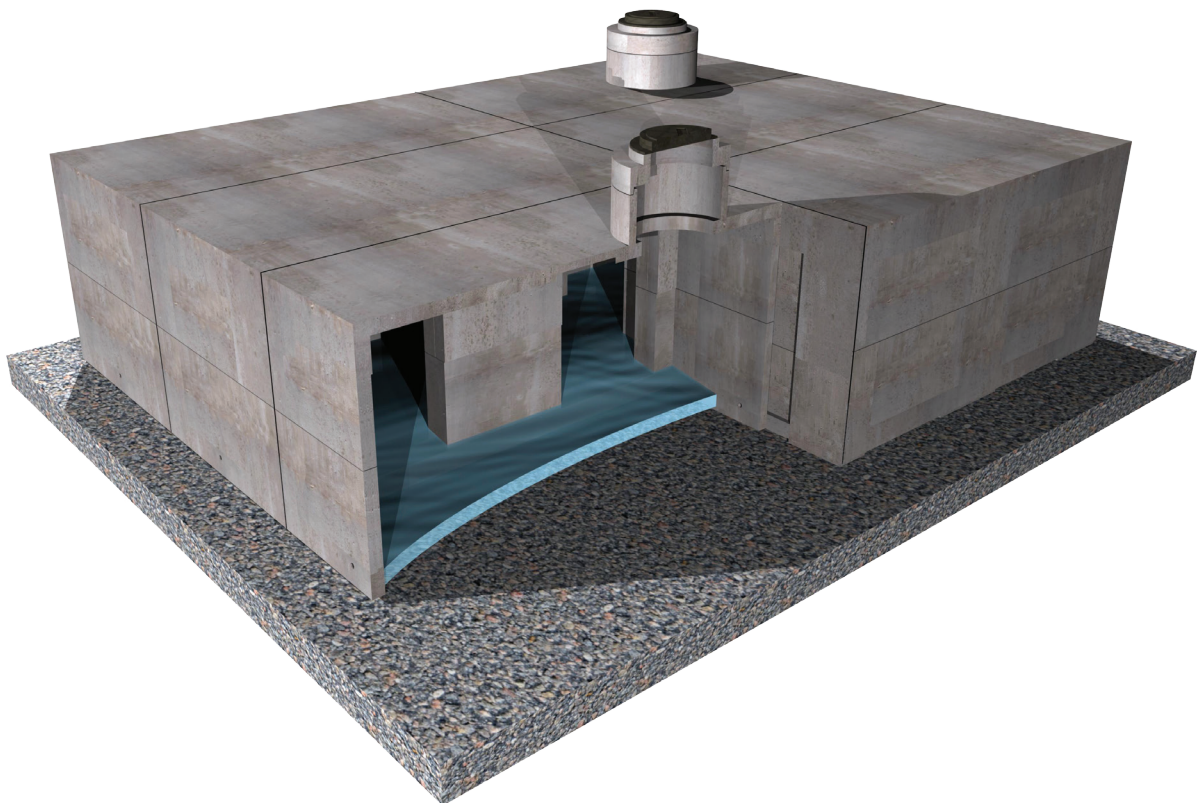



## **Description**

The StormCapture® system is an underground, modular, structural precast concrete storage system for stormwater detention, retention, infiltration, harvesting and reuse, and water quality volume storage. The system's modular design utilizes multiple standard precast concrete units with inside dimensions of 7 feet by 15 feet (outside dimensions of 8 feet by 16 feet) to form a larger storage system. The inside height of the StormCapture system can range from 2 feet to 14 feet. This modular design provides limitless configuration options for site-specific layouts.

StormCapture components can be provided as either open-bottom modules to promote infiltration or closed-bottom modules for detention. In some cases, StormCapture modules can be placed in a checkerboard configuration for an even more efficient design. A Link Slab, with a footprint of 9 feet by 17 feet, is then used to bridge each space without a module.

The standard StormCapture design incorporates lateral and longitudinal passageways between modules to accommodate internal stormwater conveyance throughout the system. These passageways may be classified as either a "window configuration" with standard 12-inch tall sediment baffles extending up from the floor of the module to the bottom of the window, or a "doorway configuration" without the sediment baffles. The function and drainage rate of a StormCapture system depends on site-specific conditions and requirements.

Stormwater typically enters the StormCapture system through an inlet pipe. Grated inlets can also be used for direct discharge into the system. The StormCapture system is rated for H-20 traffic loading with limited cover. Higher load requirements can also be accommodated. In addition, StormCapture systems are typically equipped with a limited number of maintenance modules that provide access to the system for ongoing inspection and maintenance.

## **Function**

The StormCapture system is primarily used to manage water quantity by temporarily storing stormwater runoff from impervious surfaces to prevent flooding, slow down the rate at which stormwater leaves the site, and reduce receiving stream erosion. In addition, the StormCapture system can be used to capture stormwater runoff for water quality treatment. Regardless of how the StormCapture system is used, some sedimentation may occur in the modules during the time water is stored.

## **Configurations**

The configuration of the StormCapture systems may vary, depending on the water quality and/or quantity requirements of the site. StormCapture configurations for detention, retention/infiltration, and retention/harvesting are described below.

## **Detention**

StormCapture Detention systems are designed with a closed bottom to detain stormwater runoff for controlled discharge from the site. This design may incorporate a dead storage sump and a permanent pool of water if the outlet pipe is higher than the floor elevation. Discharge from the system is typically controlled by an outlet orifice and/or outlet weir to regulate the rate of stormwater leaving the system. StormCapture Detention systems are typically designed with silt-tight joints, however when conditions exist that require a StormCapture system to be watertight, the system may be wrapped in a continuous, impermeable geomembrane liner. If the StormCapture Detention system includes Link Slabs, a liner must be used to detain water since the chambers under each Link Slab have no floor slab. In this case, care must be taken by maintenance personnel not to damage the exposed liner beneath each Link Slab.



## **Retention/Infiltration**

StormCapture Retention/Infiltration systems are designed with an open bottom to allow for the retention of stormwater onsite through infiltration into the base rock and surrounding soils. For infiltration systems, the configuration of the base of the StormCapture system may vary, depending on the needs of the site and the height of the system. Some systems may use modules that have fully open bottoms with no concrete floor, while other systems may use modules that incorporate floor openings in the base of each module. These are typically 24-inch by 24-inch openings. For open-bottom systems, concrete splash pads may be installed below inlet grate openings and pipe inlets to prevent erosion of base rock. A StormCapture Infiltration system may have an elevated discharge pipe for peak overflow.

## **Retention/Harvesting**

StormCapture Retention/Harvesting systems are similar to detention systems using closed-bottom modules, but stormwater is typically retained onsite for an extended period of time and later reused for non-potable applications or irrigation. For rainwater harvesting systems, an impermeable geomembrane liner is typically installed around the modules to provide a water-tight system.

## **Inspection and Maintenance Overview**

State and local regulations typically require all stormwater management systems to be inspected on a regular basis and maintained as necessary to ensure performance and protect downstream receiving waters. Inspections should be used to evaluate the conditions of the system. Based on these inspections, maintenance needs can be determined. Maintenance needs vary by site and system. Using this Inspection & Maintenance Guide, qualified maintenance personnel should be able to provide a recommendation for maintenance needs. Requirements may range from minor activities such as removing trash, debris or pipe blockages to more substantial activities such as vacuuming and removal of sediment and/or non-draining water. Long-term maintenance is important to the operation of the system since it prevents excessive pollutant buildup that may limit system performance by reducing the operating capacity and increasing the potential for scouring of pollutants during periods of high flow.

Only authorized personnel shall inspect and/or enter a StormCapture system. Personnel must be properly trained and equipped before entering any underground or confined space structure. Training includes familiarity with and adherence to any and all local, state and federal regulations governing confined space access and the operation, inspection, and maintenance of underground structures.

## **Inspection and Maintenance Frequency**

The StormCapture system should be inspected on a regular basis, typically twice per year, and maintained as required. The maintenance frequency will be driven by the amount of runoff and pollutant loading encountered by a given system. Local jurisdictions may also dictate inspection and maintenance frequencies.

## Inspection Equipment

The following equipment is helpful when conducting StormCapture inspections:

- Recording device (pen and paper form, voice recorder, iPad, etc.)
- Suitable clothing (appropriate footwear, gloves, hardhat, safety glasses, etc.)
- Traffic control equipment (cones, barricades, signage, flagging, etc.)
- Manhole hook or pry bar
- Confined space entry equipment, if needed
- Flashlight
- Tape measure
- Measuring stick or sludge sampler
- Long-handled net (optional)

## Inspection Procedures

A typical StormCapture system provides strategically placed access points that may be used for inspection. StormCapture inspections are usually conducted visually from the ground surface, without entering the unit. This typically limits inspection to the assessment of sediment depth, water drain down, and general condition of the modules and components, but a more detailed assessment of structural condition may be conducted during a maintenance event.

To complete an inspection, safety measures including traffic control should be deployed before the access covers are removed. Once the covers have been removed, the following items should be inspected and recorded (see form provided at the end of this document) to determine whether maintenance is required:

- Observe inlet and outlet pipe penetrations for blockage or obstruction.
- If possible, observe internal components like baffles, flow control weirs or orifices, and steps or ladders to determine whether they are broken, missing, or possibly obstructed.
- Observe, quantify, and record the sediment depths within the modules.
- Retrieve as much floating trash as possible with a long-handled net. If a significant amount of trash remains, make a note in the Inspection & Maintenance Log.
- For infiltration systems, local regulations may require monitoring of the system to ensure drain down is occurring within the required permit time period (typically 24 to 72 hours). If this is the case, refer to local regulations for proper inspection procedure.

## Maintenance Indicators

Maintenance should be scheduled if any of the following conditions are identified during the inspection:

- Inlet or outlet piping is blocked or obstructed.
- Internal components are broken, missing, or obstructed.
- Accumulation of more than six inches of sediment on the system floor or in the sump, if applicable.
- Significant accumulation of floating trash and debris that cannot be retrieved with a net.
- The system has not drained completely after it hasn't rained for one to three days, or the drain down does not meet permit requirements.
- Any hazardous material is observed or reported.

## Maintenance Equipment

The following equipment is helpful when conducting StormCapture maintenance:

- Suitable clothing (appropriate footwear, gloves, hardhat, safety glasses, etc.)
- Traffic control equipment (cones, barricades, signage, flagging, etc.)
- Manhole hook or pry bar
- Confined space entry equipment, if needed
- Flashlight
- Tape measure
- Vacuum truck

## Maintenance Procedures

Maintenance should be conducted during dry weather when no flow is entering the system. Confined space entry is usually required to maintain the StormCapture. Only personnel that are OSHA Confined Space Entry trained and certified may enter underground structures. Once safety measures such as traffic control have been deployed, the access covers may be removed and the following activities may be conducted to complete maintenance:

- Remove trash and debris using an extension on the end of the boom hose of the vacuum truck. Continue using the vacuum truck to completely remove accumulated sediment. Some jetting may be necessary to fully evacuate sediment from the system floor or sump. Jetting is acceptable in systems with solid concrete floors or base slabs (referred to as closed-bottom systems). However, jetting is not recommended for open-bottom systems with a gravel foundation since it may cause bedding displacement, undermining of the foundation, or internal disturbance.
- All material removed from the system during maintenance must be disposed of in accordance with local regulations. In most cases, the material may be handled in the same manner as disposal of material removed from sumped catch basins or manholes.
- Inspect inlet and outlet pipe penetrations for cracking and other signs of movement that may cause leakage.
- Inspect the concrete splash pads (applicable for open-bottom systems only) for proper function and placement.
- Inspect the system for movement of modules. There should be less than 3/4-inch spacing between modules.
- Inspect the general interior condition of modules for concrete cracking or deterioration. If the system consists of horizontal joints as part of the modules, inspect those joints for leakage, displacement or deterioration.

Be sure to securely replace all access covers, as appropriate, following inspection and/or maintenance. If the StormCapture modules or any of the system components show significant signs of cracking, spalling, or deterioration or if there is evidence of excessive differential settlement between modules, contact Oldcastle Stormwater at **800-579-8819**.

# StormCapture Inspection & Maintenance Log

Refer to as-built records for details about system size and location onsite

Location \_\_\_\_\_

## System Configuration:

Inspection Date \_\_\_\_\_

Detention     Infiltration     Retention/Harvesting

## *Inlet or Outlet Blockage or Obstruction*

Notes:

Yes     No

## *Condition of Internal Components*

Notes:

Good     Damaged     Missing

## *Sediment Depth Observed*

Notes:

Inches of Sediment: \_\_\_\_\_

## *Trash and Debris Accumulation*

Notes:

Significant     Not Significant

## *Drain Down Observations*

Notes:

Appropriate Time Frame     Inappropriate Time Frame

## *Maintenance Required*

Yes - Schedule Maintenance     No - Inspect Again in \_\_\_\_\_ Months

# STORMCAPTURE®

## OUR MARKETS



BUILDING  
STRUCTURES



COMMUNICATIONS



WATER



ENERGY



TRANSPORTATION

## **APPENDIX H**

### **COVENANT AND AGREEMENT**

---

RECORDING REQUESTED BY  
AND MAIL TO:

COUNTY OF LOS ANGELES  
DEPARTMENT OF PUBLIC WORKS  
BUILDING AND SAFETY DIVISION  
900 S. FREMONT AVENUE, 3RD FLOOR  
ALHAMBRA, CA 91803-1331

Space above this line is for Recorder's use

**COVENANT AND AGREEMENT**  
**REGARDING THE MAINTENANCE OF LOW IMPACT DEVELOPMENT (LID) &**  
**NATIONAL POLLUTANTS DISCHARGE ELIMINATION SYSTEM (NPDES) BMPs**

The undersigned, \_\_\_\_\_ ("Owner"), hereby certifies that it owns the real property described as follows ("Subject Property"), located in the County of Los Angeles, State of California:

LEGAL DESCRIPTION

ASSESSOR'S ID # \_\_\_\_\_ TRACT NO. \_\_\_\_\_ LOT NO. \_\_\_\_\_

ADDRESS: \_\_\_\_\_  
\_\_\_\_\_

Owner is aware of the requirements of the County of Los Angeles' Green Building Standards Code, Title 31, Section 4.106.4 (LID), and National Pollutant Discharge Elimination System (NPDES) permit. The following post-construction BMP features have been installed on the Subject Property:

- Porous pavement
- Cistern/rain barrel
- Infiltration trench/pit
- Bioretention or biofiltration
- Rain garden/planter box
- Disconnect impervious surfaces
- Dry Well
- Storage containers
- Landscaping and landscape irrigation
- Green roof
- Other \_\_\_\_\_

The location, including GPS x-y coordinates, and type of each post-construction BMP feature installed on the Subject Property is identified on the site diagram attached hereto as Exhibit 1.

Owner hereby covenants and agrees to maintain the above-described post-construction BMP features in a good and operable condition at all times, and in accordance with the LID/NPDES Maintenance Guidelines, attached hereto as Exhibit 2.

Owner further covenants and agrees that the above-described post-construction BMP features shall not be removed from the Subject Property unless and until they have been replaced with other post-construction BMP features in accordance with County of Los Angeles' Green Building Standards Code, Title 31 and NPDES permit.

Owner further covenants and agrees that if Owner hereafter sells the Subject Property, Owner shall provide printed educational materials to the buyer regarding the post-construction BMP features that are located on the Subject Property, including the type(s) and location(s) of all such features, and instructions for properly maintaining all such features.

Owner makes this Covenant and Agreement on behalf of itself and its successors and assigns. This Covenant and Agreement shall run with the Subject Property and shall be binding upon owner, future owners, and their heirs, successors and assignees, and shall continue in effect until the release of this Covenant and Agreement by the County of Los Angeles, in its sole discretion.

Owner(s):

By: \_\_\_\_\_ Date: \_\_\_\_\_

By: \_\_\_\_\_ Date: \_\_\_\_\_

(PLEASE ATTACH NOTARY)

REFERENCE

PLAN CHECK NO.: \_\_\_\_\_ DISTRICT OFFICE NO.: \_\_\_\_\_

ATTACHMENTS

RECORDING REQUEST BY AND MAIL TO:

County of Los Angeles  
Department of Public Works

Building and Safety – Drainage and Grading Section  
Land Development – Drainage and Grading Section

P.O. Box 1460  
Alhambra, California 91802-1460

Space above this line is for Recorder's use

**COVENANT FOR MAINTENANCE OF WATER QUALITY (WQ) DEVICES**

I (we) \_\_\_\_\_, hereby certify that I (we) am (are) the legal owner(s) of Tract # \_\_\_\_\_, and as such owners for the mutual benefit of future purchasers, their heirs, successors, and assigns, do hereby fix the following protective conditions to which their property, or portions thereof, shall be held, sold and/or conveyed.

That owner(s) shall maintain the WQ system shown on attached Exhibit A map and on Grading Plan GPC # \_\_\_\_\_, on file in the office of the Director of Public Works, in a good and functional condition at least once a year and retain proof of the inspection. The owner(s) shall perform this responsibility, unless the County discharges this obligation through a subsequently recorded written instrument.

The undersigned also covenants and agrees for himself, his heirs, successors, and assigns, to indemnify, defend, and save harmless the County, its agents, officers and employees from and against any and all liability, expenses, including defense costs and legal fees, and claims for damages of any nature whatsoever, including, but not limited to, bodily injury, death, personal injury, or property damage arising from or connected with the construction or maintenance of said work.

Owner(s):

By: \_\_\_\_\_ Date: \_\_\_\_\_

By: \_\_\_\_\_ Date: \_\_\_\_\_



## **APPENDIX I**

### **GEOTECHNICAL REPORT (FOR REFERENCE ONLY)**

---



# Converse Consultants

Geotechnical Engineering, Environmental & Groundwater Science, Inspection & Testing Services

## **GEOTECHNICAL STUDY REPORT Proposed Student Center Building Mt. San Antonio College 1100 North Grand Avenue Walnut, California 91789**

Converse Project No. 17-31-234-01

Prepared For:

Mt. San Antonio College  
Facilities and Planning Management  
Building 46  
1100 North Grand Avenue  
Walnut, California 91789

Prepared By:

Converse Consultants  
717 South Myrtle Avenue  
Monrovia, California 91016

October 5, 2017



# Converse Consultants

Geotechnical Engineering, Environmental & Groundwater Science, Inspection & Testing Services

October 5, 2017

Mr. Gary Gidcumb  
Mt. San Antonio College  
Facilities Planning & Management  
1100 North Grand Avenue, Building 46  
Walnut, California 91789

Subject: **GEOTECHNICAL STUDY REPORT**  
**Proposed New Student Center Building**  
1100 North Grand Avenue  
Walnut, California  
Mt. San Antonio College  
Converse Project No. 17-31-234-01

Dear Mr. Gidcumb:

Enclosed is a Geotechnical Study Report prepared by Converse Consultants (Converse) for the proposed New Student Center Building at Mt. San Antonio College located in the City of Walnut, Los Angeles County, California.

The purpose of the study was to generate a geotechnical study report for design parameters and Division of State Architect (DSA) submittal purposes consistent with the current edition of California Building Code, Title 24, Chapter 16; Earthquake Design, Chapter 18A, Foundation and Retaining Wall; Appendix Chapter 33, Excavation and Grading; Part 1' Section 4-317 (e) and CGS Note 48-Checklist for the Review of Engineering Geology and Seismology Reports for California Public Schools, Hospitals and Essential Services Buildings.

Based on our field exploration, laboratory testing, geologic evaluation and geotechnical analysis, the site is suitable from a geotechnical standpoint for the proposed new Student Center Building.

We appreciate the opportunity to be of service to Mt. San Antonio College. If you should have any questions, please do not hesitate to contact us at (626) 930-1275.

Sincerely,

## CONVERSE CONSULTANTS

Siva K. Sivathasan, PhD, PE, GE, DGE, QSD, F. ASCE  
Senior Vice President / Principal Engineer

Dist: 3/Addressee



## PROFESSIONAL CERTIFICATION

This report for the proposed new Student Center Building at Mt. San Antonio College in the City of Walnut, California, has been prepared by the staff of Converse Consultants under the professional supervision of the individuals whose seals and signatures appear hereon.

The findings, recommendations, specifications or professional opinions contained in this report were prepared in accordance with generally accepted professional engineering and engineering geologic principles and practice in this area of Southern California. There is no warranty, either expressed or implied.

In the event that changes to the property occur, or additional, relevant information about the property is brought to our attention, the conclusions contained in this report may not be valid unless these changes and additional relevant information are reviewed and the recommendations of this report are modified or verified in writing.



---

Victor Nguyen, EIT  
Senior Staff Engineer

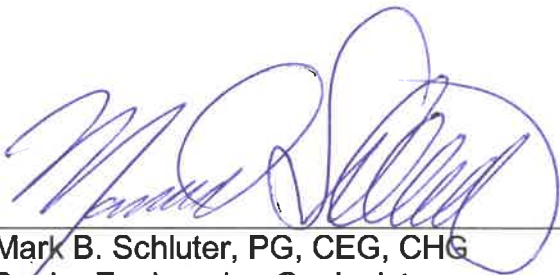

---

Mark B. Schluter, PG, CEG, CHG  
Senior Engineering Geologist



---

Siva K. Sivathasan, PhD, PE, GE, DGE, QSD, F. ASCE  
Senior Vice President/Principal Engineer



## EXECUTIVE SUMMARY

The following is a summary of our geotechnical study, findings, conclusions, and recommendations, as presented in the body of this report. Please refer to the appropriate sections of the report for complete conclusions and recommendations. In the event of a conflict between this summary and the report, or an omission in the summary, the report shall prevail.

- The proposed new Student Center Building is to be located within the central portion of the existing Mt. San Antonio College campus. The project site is bounded by Building No. 13 to the north, Building No. 19c to the south, Building No. 26D to the east, and Building No. 10 to the west. Building Nos. 17, 18, 19A, and 19B currently occupy the proposed project site.
- Eight (8) exploratory borings (BH-1 through BH-8) were advanced within the project site on August 14, 2017, August 15, 2017, and August 24, 2017. The borings were advanced using a truck-mounted drill rig with an 8-inch diameter hollow stem auger to a maximum depth of 51.5 feet below the existing ground surface (bgs) and by hand-auger excavation methods (BH-4 and BH-6) for limited access areas.
- The earth materials encountered during our investigation consisted of existing fill soils placed during previous site grading operations and natural alluvial sediments to a maximum explored depth of 51.5 feet bgs. Undocumented fills, approximately three (3) to five (5) feet in thickness, were encountered in the borings. Deeper artificial fills may exist at the project site. The fills encountered consisted primarily of silty sand, clayey sand, sandy clay, and silty clayey sand. The alluvial sediment deposits below the surface fills primarily consisted of fine-grained clays, clayey sands, silty sands, silts, and sandy silts.
- Groundwater was encountered during the time of drilling in Boring BH-5 at a depth of approximately 47.5 feet bgs.
- The project site is not located within a currently designated State of California Earthquake Fault Zone for surface fault rupture. No active surface faults are known to project through or towards the site.
- The project site is located within a mapped potential liquefaction zone per the State of California Seismic Hazard Zones Map for the San Dimas Quadrangle. The results of liquefaction analyses indicate the site soils are not susceptible to liquefaction. The estimated potential seismically induced settlement for BH-1 and BH-5 are 1.55-inches and 1.67-inches, respectively. The estimated potential differential settlement for BH-1 and BH-5 are 0.78-inch and 0.84-inch, respectively.

- We recommend the proposed new Student Center Building be supported on shallow spread foundations provided our earthwork recommendations are incorporated in the design and construction.
- The project will consist of clearing the site, removal of trees and surface vegetation, demolition and removal of existing buildings and utilities, removal of existing sidewalks, pavements, and slabs, and remedial grading consisting of over-excavation and re-compaction of the surface soils to provide structural support for new building pads and improvements.
- Based on the field investigation, the near-surface earth materials are primarily silty sand, clayey sand, and silt. The site soils were tested for expansion potential per ASTM Standard D4829 and were found to have “very low” expansion potential.
- In accordance with the Caltrans Corrosive Guidelines (2015), water soluble sulfates in the soil indicate that concrete exposed has no restrictions on cement type or water-cement ratio. The pH, chloride concentrations, resistivity, and sulfate concentrations fall in the “non-corrosive” range for structural elements.
- Percolation testing was performed utilizing exploratory boring BH-4 on August 24, 2017. The field tests resulted in an average percolation rate of 1.74 inches/hour and a lowest percolation rate of 1.35 inches/hour.
- Thicknesses of flexible pavement structural sections were calculated using a laboratory obtained R-Value of 17. The recommended flexible pavement structural sections for various traffic index (TI) conditions are presented in Table No. 11, Flexible Pavement Structural Sections.
- Based on our field exploration, the earth materials at the project site should be excavatable with conventional heavy-duty earth moving and trenching equipment.

Results of our study indicate that the site is suitable from a geotechnical standpoint for the proposed development, provided that the recommendations contained in this report are incorporated into the design and construction of the project.

## TABLE OF CONTENTS

<b>1.0 INTRODUCTION.....</b>	<b>1</b>
<b>2.0 SITE AND PROJECT DESCRIPTION.....</b>	<b>2</b>
2.1 SITE DESCRIPTION .....	2
2.2 PROJECT DESCRIPTION .....	2
<b>3.0 SCOPE OF WORK .....</b>	<b>3</b>
3.1 REVIEW OF EXISTING DOCUMENTS.....	3
3.2 SUBSURFACE EXPLORATION AND PERCOLATION TESTING.....	3
3.3 LABORATORY TESTING .....	3
3.4 ANALYSES AND REPORT .....	4
<b>4.0 GEOLOGIC CONDITIONS.....</b>	<b>5</b>
4.1 REGIONAL GEOLOGIC SETTING .....	5
4.2 SUBSURFACE PROFILE OF PROJECT SITE .....	5
4.3 GROUNDWATER .....	6
4.4 SUBSURFACE VARIATIONS .....	6
<b>5.0 FAULTING AND SEISMIC HAZARDS.....</b>	<b>7</b>
5.1 SEISMIC CHARACTERISTICS OF NEARBY FAULTS .....	7
5.2 SEISMIC HISTORY.....	9
5.3 SURFACE FAULT RUPTURE .....	10
5.4 LIQUEFACTION AND SEISMICALLY-INDUCED SETTLEMENT .....	10
5.5 LATERAL SPREADING .....	10
5.6 SEISMICALLY-INDUCED SLOPE INSTABILITY .....	11
5.7 EARTHQUAKE-INDUCED FLOODING .....	11
5.8 TSUNAMI AND SEICHES.....	11
5.9 VOLCANIC ERUPTION HAZARD .....	11
<b>6.0 SEISMIC ANALYSIS .....</b>	<b>12</b>
6.1 CBC SEISMIC DESIGN PARAMETERS .....	12
6.2 SITE-SPECIFIC RESPONSE SPECTRA .....	12
<b>7.0 GEOTECHNICAL EVALUATIONS AND CONCLUSIONS.....</b>	<b>15</b>
<b>8.0 DESIGN RECOMMENDATIONS .....</b>	<b>17</b>
8.1 GENERAL EVALUATION .....	17
8.2 SHALLOW FOUNDATIONS .....	17
8.3 SLABS-ON-GRADE.....	18
8.4 MODULUS OF SUBGRADE REACTION.....	19
8.5 LATERAL EARTH PRESSURE.....	19
8.6 SOIL CORROSIVITY EVALUATION .....	20
8.7 PERCOLATION TESTING .....	21
8.8 FLEXIBLE PAVEMENT DESIGN.....	22
8.9 SITE DRAINAGE.....	23
8.10 SLOPE MAINTENANCE AND EROSION CONTROL .....	23

<b>9.0 EARTHWORK AND SITE GRADING RECOMMENDATIONS.....</b>	<b>25</b>
9.1 GENERAL EVALUATION .....	25
9.2 OVER-EXCAVATION .....	25
9.3 STRUCTURAL FILL .....	27
9.4 SUBGRADE PREPARATION .....	27
9.5 EXCAVATABILITY .....	27
9.6 PIPELINE SUBGRADE PREPARATION .....	27
9.7 PIPE BEDDING.....	28
9.8 TRENCH ZONE BACKFILL .....	28
9.9 EXPANSIVE SOIL MITIGATION .....	30
9.10 SHRINKAGE AND SUBSIDENCE.....	30
<b>10.0 CONSTRUCTION CONSIDERATIONS.....</b>	<b>31</b>
10.1 GENERAL.....	31
10.2 TEMPORARY EXCAVATIONS.....	31
10.3 GEOTECHNICAL SERVICES DURING CONSTRUCTION.....	31
<b>11.0 CLOSURE.....</b>	<b>33</b>
<b>12.0 REFERENCES.....</b>	<b>34</b>

## TABLES

	Page Number
Table No. 1, <i>Summary of Regional Faults</i> .....	8
Table No. 2, <i>CBC Seismic Design Parameters</i> .....	12
Table No. 3, <i>2016 CBC Mapped Acceleration Parameters</i> .....	13
Table No. 4, <i>Probabilistic Response Spectrum Data</i> .....	13
Table No. 5, <i>Site-Specific Response Spectrum Data</i> .....	14
Table No. 6, <i>Site-Specific Seismic Design Parameters</i> .....	14
Table No. 7, <i>Lateral Earth Pressures for Retaining Wall Design</i> .....	19
Table No. 8, <i>Soil Corrosivity Test Results</i> .....	20
Table No. 9, <i>Boring Percolation Test Result</i> .....	21
Table No. 10, <i>Infiltration Facility Setback Requirements per Los Angeles County</i> .....	22
Table No. 11, <i>Flexible Pavement Structural Sections</i> .....	22
Table No. 12, <i>Slope Ratios for Temporary Excavations</i> .....	31

## DRAWINGS

	Following Page Number
Drawing No. 1, <i>Site Location Map</i> .....	1
Drawing No. 2, <i>Site Plan and Approximate Location of Borings</i> .....	2
Drawing No. 3, <i>Regional Geologic Map</i> .....	5
Drawing No. 4, <i>Geologic Cross Section A-A'</i> .....	6
Drawing No. 5, <i>Geologic Cross Section B-B'</i> .....	6
Drawing No. 6, <i>Southern California Regional Fault Map</i> .....	7
Drawing No. 7, <i>Epicenter Map of Southern California Earthquakes (1800-1999)</i> .....	9
Drawing No. 8, <i>Seismic Hazard Zones Map</i> .....	10
Drawing No. 9, <i>Site Specific Design Response Spectrum</i> .....	14



## APPENDICES

Appendix A .....	<i>Field Exploration</i>
Appendix B .....	<i>Laboratory Testing Program</i>
Appendix C .....	<i>Liquefaction/Seismic Settlement Analysis</i>
Appendix D .....	<i>Earthwork Specifications</i>
Appendix E .....	<i>Percolation Testing</i>

## 1.0 INTRODUCTION

This report contains the findings and recommendations of our geotechnical study performed at the site of the proposed new Student Center Building located within the central portion of the Mt. San Antonio College campus in the City of Walnut, Los Angeles County, California, as shown in Drawing No. 1, *Site Location Map*.

The purpose of the study was to generate a geotechnical soils report for design and Division of State Architect (DSA) submittal purposes, consistent with the latest edition of California Building Code (CBC), Title 24, Chapter 16; Earthquake Design, Chapter 18A, Foundation and Retaining Wall; Appendix Chapter 33, Excavation and Grading; Part 1, Section 4-317 (e) and the current CGS Note 48-Checklist.

This report is written for the project described herein and is intended for use solely by Mt. San Antonio College and their design team. It should not be used as a bidding document but may be made available to the potential contractors for information on factual data only. For bidding purposes, the contractors should be responsible for making their own interpretation of the data contained in this report.



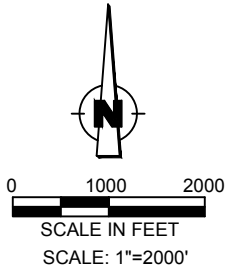

REFERENCE: USGS MA □  
SAN DIMAS QUADRANGLE 19 □□  
HOTO REVISED 19 □

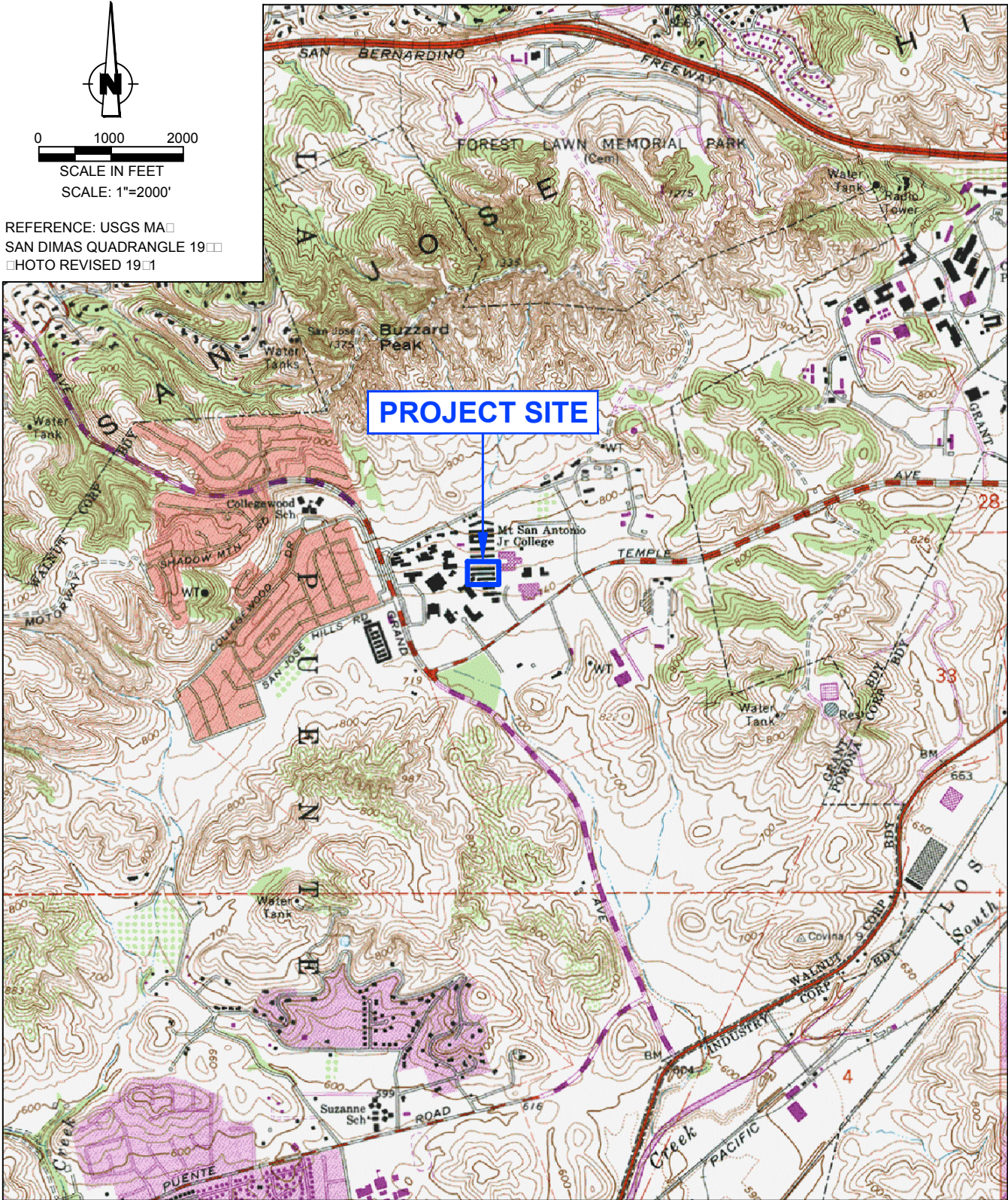

### SITE LOCATION MAP

STUDENT CENTER BUILDING  
MT. SAN ANTONIO COLLEGE  
WALNUT, CALIFORNIA

Project No.  
17-31-234-01



Drawing No.

1



## **2.0 SITE AND PROJECT DESCRIPTION**

### **2.1 Site Description**

The proposed new Student Center Building is to be located within the central portion of the existing Mt. San Antonio College campus. The project site is bounded by Building No. 13 to the north, Building No. 19c to the south, Building No. 26D to the east and Building No. 10 to the west. Building Nos. 17, 18, 19A, and 19B currently occupy the proposed project site.

The site coordinates for the proposed Student Center Building are: 34.04696 degrees North Latitude, -117.84507 degrees West Longitude. The site coordinates were centered on the subject site and used to calculate the earthquake ground motions. Review of Engineering Geology and Seismology for Public Schools and Hospitals in California, dated August 9, 2005 indicates that accuracy to within a few hundred meters of these coordinates is sufficient for the computation of the earthquake ground motion of the project site.

### **2.2 Project Description**

The proposed project will consist of demolition of the existing, single-story, Building Nos. 17, 18, 19A, and 19B to allow for the grading and construction of the proposed new Student Center Building. The new Student Center Building will consist of one building with three stories and an approximate building height of 65 feet. The grade difference between the north and south sides of the building will be approximately 18 feet sloping in a north to south direction. The footprint area of the building is approximately 34,500 square feet with a total square footage of approximately 100,000 square feet.

The Student Center Building will provide space for student life offices, student organization offices, multi-cultural center, sit and study spaces, sit and relax spaces, food services including café, coffeehouse and convenience store, conference center, ball room, event center, and loading and storage areas.

Access to the building's first floor level will be from the south side at the Plaza level. Access to the building from the north side will be at the second level along the Miracle Mile Level. The building will be provided with exterior elevators for accessibility. The exterior spaces around the building will include plazas at both levels, stairs, retaining walls and landscaping. The structural loads are not known at this time, but are anticipated to be moderate. The project site and boring locations are shown in Drawing No. 2, *Site Plan and Approximate Location of Borings*.

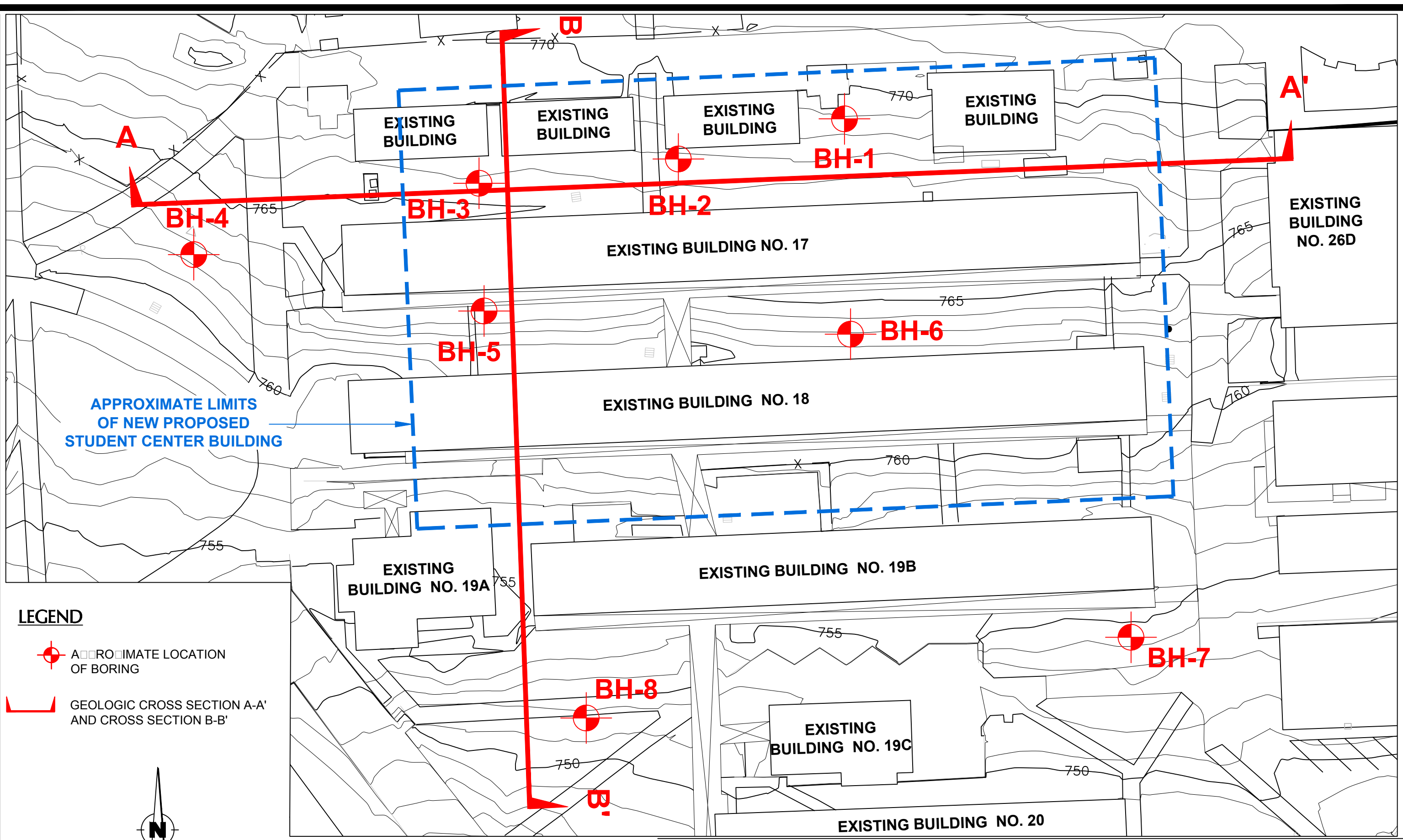

**LEGEND**

 APPROXIMATE LOCATION OF BORING

 GEOLOGIC CROSS SECTION A-A' AND CROSS SECTION B-B'

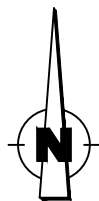

0 40 80  
APPROXIMATE SCALE IN FEET

**SITE PLAN AND APPROXIMATE LOCATION OF BORINGS**

### **3.0 SCOPE OF WORK**

Our scope of work consists of the tasks described in the following subsections.

#### **3.1 *Review of Existing Documents***

Our field exploration included review of existing documents by a member of the Converse Staff. The purpose of the review was to have an understanding of the site geology and subsurface soils prior to subsurface exploration.

#### **3.2 *Subsurface Exploration and Percolation Testing***

Eight (8) exploratory borings (BH-1 through BH-8) were advanced within the project site on August 14, 2017, August 15, 2017, and August 24, 2017. The borings were advanced using a truck mounted drill rig with an 8-inch diameter hollow stem auger to a maximum depth of 51.5 feet below the existing ground surface (bgs) and hand-auger excavation methods (BH-4 and BH-6) for limited access areas. Each boring was visually logged by a Converse engineer and sampled at regular intervals and at changes in subsurface soils. Detailed descriptions of the field exploration and sampling program are presented in Appendix A, *Field Exploration*. The approximate locations of the exploratory borings and percolation test boring are shown in Drawing No. 2, *Site Plan and Approximate Location of Borings*.

California Modified Sampler (Ring samples), Standard Penetration Test samples, and bulk soil samples were obtained for laboratory testing. Standard Penetration Tests (SPTs) were performed in selected borings at selected intervals using a standard (1.4 inches inside diameter and 2.0 inches outside diameter) split-barrel sampler. The bore holes were then backfilled and compacted with soil cuttings by reverse spinning of the augers and tamping of the soil cuttings following the completion of drilling.

#### **3.3 *Laboratory Testing***

Representative samples of the site soils were tested in the laboratory to aid in the classification and to evaluate relevant engineering properties. The tests performed included:

- In situ moisture contents and dry densities (ASTM Standard D2216)
- Grain Size Distribution (ASTM Standard C136)
- Maximum dry density and optimum-moisture content relationship (ASTM Standard D1557)
- Direct shear (ASTM Standard D3080)
- Consolidation (ASTM Standard D2435)
- Soil corrosivity tests (Caltrans 643, 422, 417, and 532)
- Expansion Index (ASTM Standard D4829)

- Sand Equivalent (ASTM Standard 2419)
- R-Value (CTM 301)

### **3.4 *Analyses and Report***

Data obtained from the exploratory fieldwork and laboratory-testing program were analyzed and evaluated with respect to the planned construction. This report was prepared to provide the findings, conclusions and recommendations developed during our study and evaluation.

## 4.0 GEOLOGIC CONDITIONS

### 4.1 *Regional Geologic Setting*

The proposed project site is located in the San Jose Hills along the western edge of the Pomona Valley within the Transverse Ranges geomorphic province of California near the northern terminus of the Peninsular Ranges Province.

The Pomona Valley is situated at the junction of the two major convergent fault systems: 1) Northwest-trending high angle strike slip faults of the San Andreas system projecting from the northern terminus of the Peninsular Ranges Province, and 2) East-trending low angle reverse or reverse-oblique faults bounding the southern margin of the Transverse Ranges. Faults in high angle strike slip fault group include the Palos Verdes, Newport-Inglewood, Whittier-Elsinore and San Jacinto fault zones. Faults in the low angle reverse and reverse-oblique group include the Malibu-Santa Monica, Hollywood, Raymond, Sierra Madre and Cucamonga fault zones.

The Pomona Valley basin is bounded to the north by the San Jose fault and to the southwest by the Chino-Central Avenue fault. These two fault systems do not exhibit significant evidence of surface movement within Holocene time (0-11,700 years before present) and are not considered active based on current geologic information. The San Jose and Chino-Central Avenue faults are considered Late Quaternary age faults, having exhibited displacement and movement within the past approximately 130,000 years.

The Geologic Map of the San Dimas and Ontario Quadrangles prepared by Thomas W. Dibblee, Jr. (DF-91, dated July 2002) was reviewed. The map shows the location of Mt. San Antonio College campus within an alluvial basin surrounded by hillsides consisting of sedimentary bedrock of the Monterey (Puente) Formation. No faults are shown running through or projecting through the project site. A natural hillside is depicted north of the subject site and has been mapped as (Tmy)-Yorba Shale Member consisting of thinly bedded, diatomaceous, semi-siliceous clay shale, siltstone and sandstone sedimentary bedrock. Drawing No. 3, *Regional Geologic Map*, has been prepared to show the project site with respect to local geology of the San Dimas Quadrangle.

### 4.2 *Subsurface Profile of Project Site*

The earth materials encountered during our investigation consist of existing fill soils placed during previous site grading operations and natural alluvial sediments to the depths explored. Undocumented fills, approximately three (3) to five (5) feet in thickness, were encountered in the borings. Deeper artificial fill may exist at the site. The fills encountered consisted primarily of silty sands, clayey sands, sandy clays, and silty clayey sands. The alluvial soil deposits below the surface fills primarily consists of fine-grained clays, clayey sands, silty sands, silts, and sandy silts. Sampling blow-counts correlate to moderately dense conditions near surface, and generally become denser with depth.



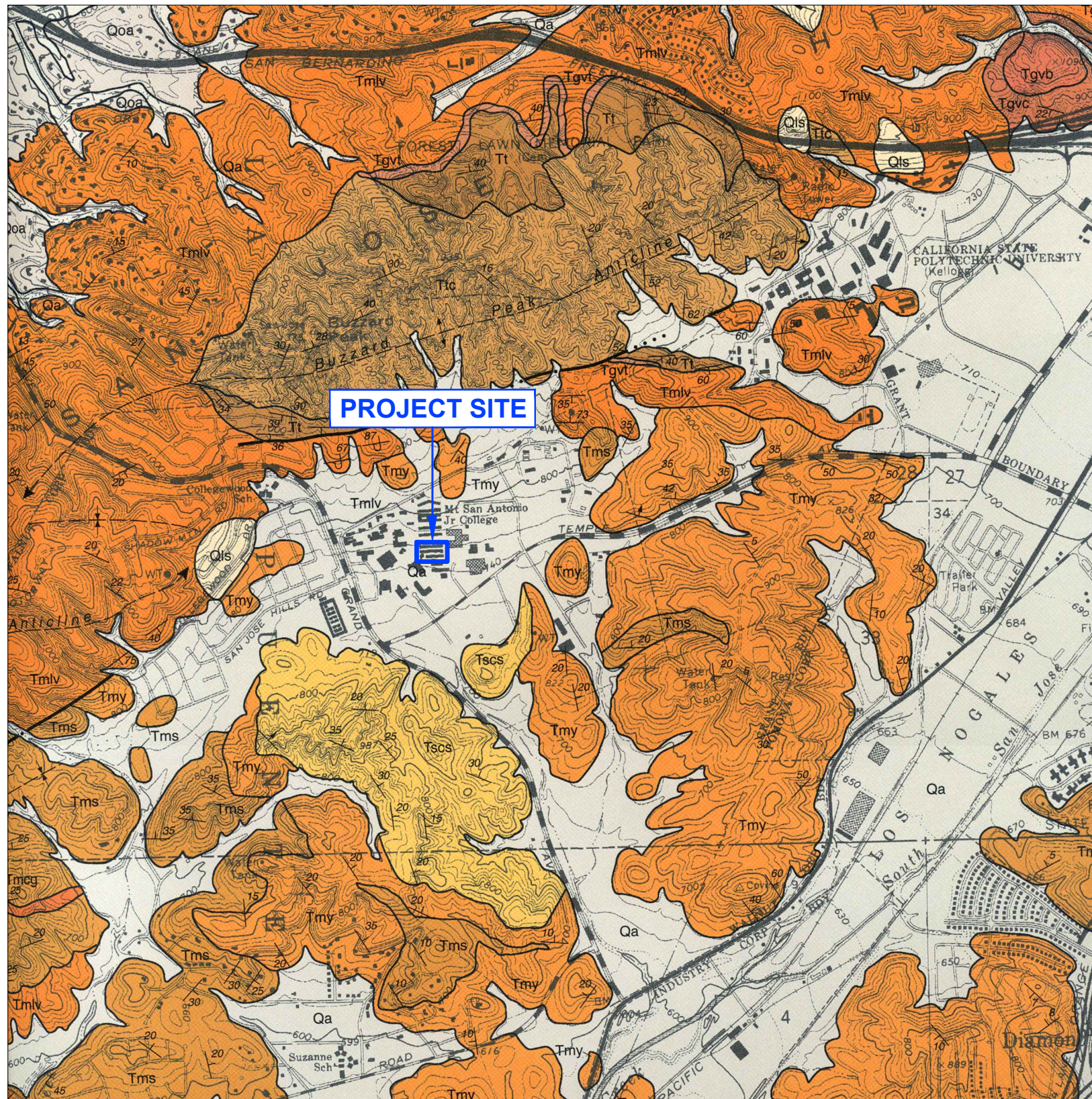
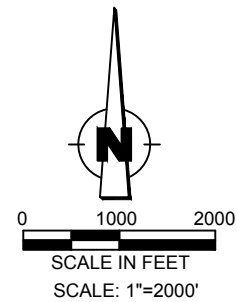

**SAN DIMAS AND ONTARIO MAP (DF-91)**

**LEGEND**

**SURFICIAL SEDIMENTS**

af artificial fill  
 Qg alluvial gravel and sand of stream channels, some artificially channelized  
 Qa alluvial gravel and sand of valley areas

**LANDSLIDE AND TALUS RUBBLE**

Qls

— UNCONFORMITY —

**OLDER, DISSECTED SURFICIAL SEDIMENTS**

Qoa low remnants of elevated alluvial gravel  
 Qog high remnants of elevated older alluvial gravel, including coarse boulder gravel

— UNCONFORMITY —

**SEDIMENTARY AND VOLCANIC ROCKS**

Tscg Tscs

**SYCAMORE CANYON FORMATION**  
 Sycamore Canyon Formation (uppermost member of Puente Formation of Durham & Yerkes 1964, Tan 1998) shallow marine clastic; latest Miocene age.  
 Tscg conglomerate, light gray, of cobbles and pebbles of plutonic rocks in sandstone matrix.  
 Tscs sandstone, light gray, similar to Tms. Includes some conglomerate similar to Tscg, and siltstone.

**MONTEREY (PUENTE) FORMATION**  
 Monterey Formation (Puente form of Eldridge & Arnold, 1907, Durham & Yerkes 1964; Tan 1998, marine biogenic & clastic; late Miocene age, (Molnarian Stage))  
 Tm unassigned shale; similar to Tmlv & Tmy  
 Tmy Yorba shale Member—light gray, thin bedded, diatomaceous, semi-siliceous to clay shale, siltstone, minor sandstone; fish scales.  
 Tmcg conglomerate facies of cobbles & pebbles of plutonic rocks in sandstone matrix lenses in unit Tms, deposited as submarine deltas.  
 Tms Sequoia sandstone facies, partly intertongued into Tmy & Tmlv, light gray to tan, moderately lithified, bedded, arkosic, contains concretions, some interbedded silty shale, derived from plutonic terrane & deposited as submarine fans, unfossiliferous  
 Tmlv La Vida Shale Member, white, weathered; thin bedded, platy, siliceous shale, clay shale, and siltstone, some strata of tan dolomite and sandstone, fish scales, foraminifera.

**TOPANGA FORMATION**  
 (of Shelton, 1955; Tan, 1998; marine clastic; middle Miocene age, unfossiliferous, locally intertongued into Glendora volcanics), age late ? Miocene  
 Tt sandstone, light gray to tan, moderately lithified, bedded, arkosic, locally pebbly, includes interbedded siltstone or clay shale.  
 Ttc conglomerate (Buzzard Peak Conglomerate member of Woodford et al. 1946, light gray to tan, semi-lithified, vaguely bedded, composed of cobbles and pebbles of mostly plutonic rocks in sandstone matrix.

**GLENDORA VOLCANIC ROCKS**  
 Glendora Volcanics (of Shelton, 1955, Tan, 1999; extrusive volcanic rocks; middle Miocene age locally intertongued into Topanga Formation), (radiometric age ±16 MA (Weigand, P.W., oral communication 2001)  
 Tgv undifferentiated volcanic rock, mostly brown andesitic flows and breccias  
 Tgvc volcanic conglomerate, gray to brown, of volcanic detritus.  
 Tgvb basalt flows, gray to black, massive to vesicular.  
 Tgvp basaltic pelagic tuff & pillow lavas.  
 Tgvt rhyolitic tuff breccia, tan to white  
 Tgva andesite flows and flow breccias, brown, porphyritic, massive.  
 Tgvr rhyolitic-dacitic flows, tan to light brown, aphanitic, massive to flow-banded, hard, fractured  
 Tgve rhyolite-dacite breccia exposed only at Elephant Hill.

— UNCONFORMITY —

**CRYSTALLINE BASEMENT ROCKS**

**GRANITIC ROCKS**

Tmda

**MOUNTAIN MEADOWS DACITE**  
 Mountain Meadows dacite (of Shelton 1955, Tan, 1999 intrusive into qd; early Miocene? Age)  
 Mda dacite light gray, hard, massive, fine grained, contains small feldspar phenocrysts and biotite flakes.

**QUARTZ DIORITIC PLUTONIC ROCKS**  
 quartz diorite; plutonic igneous rock, late Mesozoic- Cretaceous age  
 qd biotite quartz diorite, light gray, massive.  
 qdb Borsari Tonalite of Larson 1948 similar to qd, but slightly gneissoid & contains dark gray fine grained xenoliths elongated parallel to gneissoid structure up to 9 in. long.

**Geologic Time Scale:**  
 Quaternary: Holocene, Pleistocene  
 Tertiary: Miocene  
 Cenozoic: Cenozoic

REFERENCE: THOMAS W. DIBBLE, et al. DF-91  
 SAN DIMAS QUADRANGLE  
 AND ONTARIO QUADRANGLE [2002]

**REGIONAL GEOLOGIC MAP**



STUDENT CENTER BUILDING  
 MT. SAN ANTONIO COLLEGE  
 WALNUT, CALIFORNIA

Project No. Drawing No.  
 17-31-234-01 3



Drawing No. 4, *Geologic Cross Section A-A'*, and Drawing No. 5, *Geologic Cross Section B-B'*, have been drawn across the subject site to illustrate the subsurface conditions beneath the project site. For a detailed description of the materials encountered during our exploration, see Appendix A, *Field Exploration*.

#### **4.3 Groundwater**

Groundwater was encountered during the time of drilling in Boring BH-5 at a depth of approximately 47.5 feet bgs. The regional groundwater table is not expected to be encountered during the planned construction. However, the possibility of perched groundwater encountered during future grading and excavation cannot be completely precluded.

In general, groundwater levels fluctuate with the seasons and from local recharge activities. Local zones of perched groundwater may be present within the near-surface deposits due to buried alluvial channel features and remnants, local recharge conditions or during rainy seasons. Groundwater conditions below any given site vary depending on numerous factors including seasonal rainfall, local irrigation, storm water recharge and groundwater pumping, among other factors.

#### **4.4 Subsurface Variations**

Based on results of the subsurface exploration and our experience, some variations in the continuity and nature of subsurface conditions within the project site should be anticipated. Because of the uncertainties involved in the nature and depositional characteristics of the earth materials at the site, care should be exercised in interpolating or extrapolating subsurface conditions between or beyond the boring locations. If, during construction, subsurface conditions differ significantly from those presented in this report, this office should be notified immediately so that recommendations can be modified, if necessary.

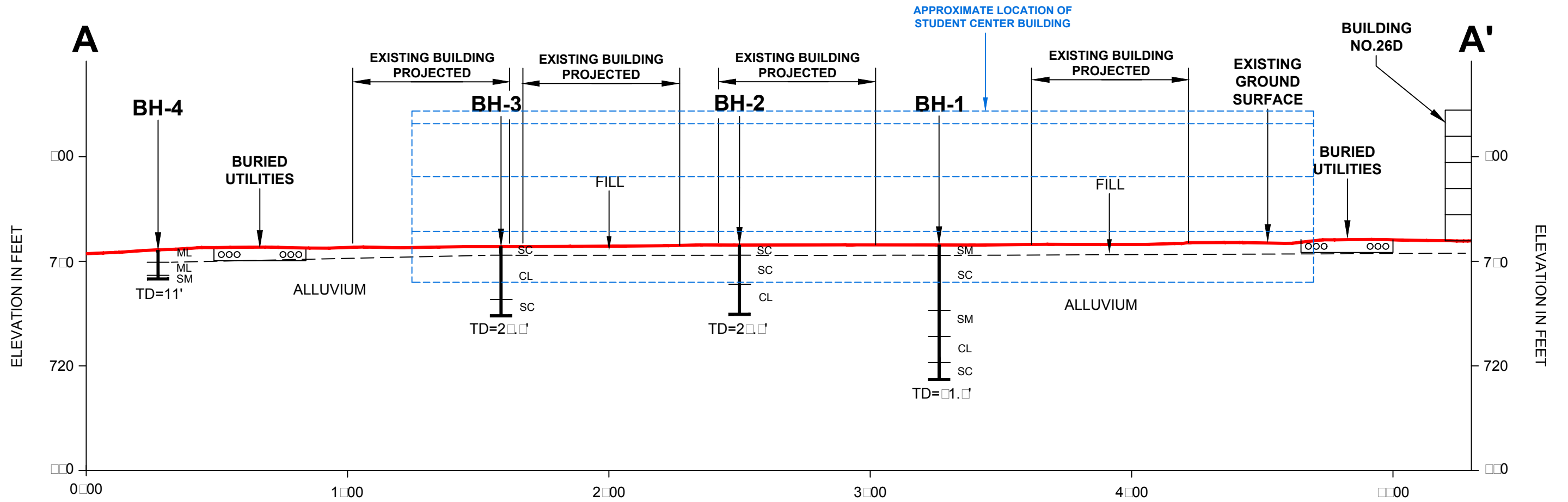

PROFILE  
 VERTICAL: 1"=40'  
 HORIZONTAL: 1"=40'

### GEOLOGIC CROSS SECTION A-A'

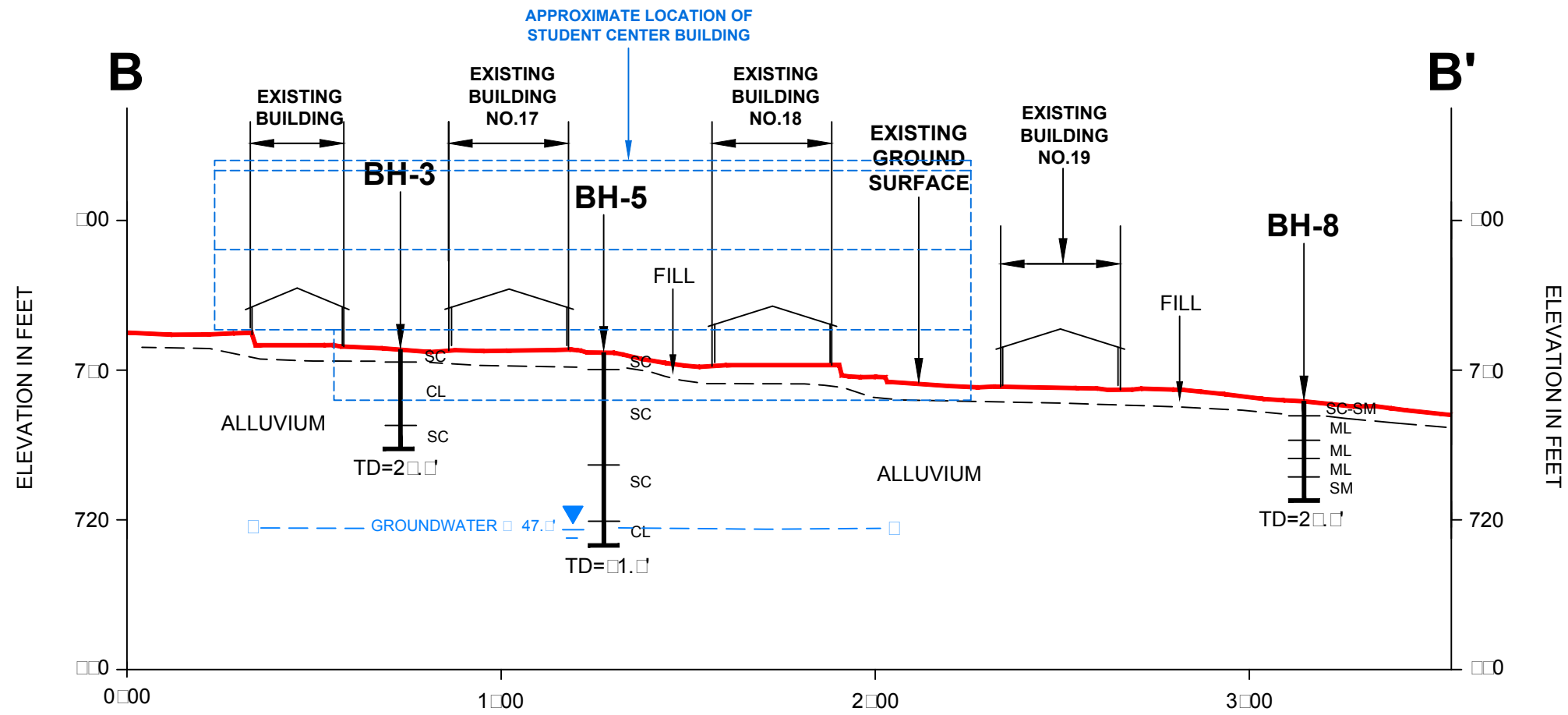

□ PROFILE  
 VERTICAL: 1"=40'  
 HORIZONTAL: 1"=40'

### GEOLOGIC CROSS SECTION B-B'

## 5.0 FAULTING AND SEISMIC HAZARDS

Geologic hazards are defined as geologically related conditions that may present a potential danger to life and property. Typical geologic hazards in Southern California include earthquake ground shaking, fault surface rupture, liquefaction and seismically induced settlement, lateral spreading, landslides, earthquake induced flooding, tsunamis and seiches, and volcanic eruption hazard.

Results of a site-specific evaluation for each type of possible seismic hazards are discussed in the following sections.

### 5.1 *Seismic Characteristics of Nearby Faults*

No surface faults are known to project through or towards the site. The closest known faults to the project site with mappable surface expressions are the San Jose Fault (located approximately 0.5 kilometers to the north) and Chino-Central Avenue (Elsinore) Fault (located approximately 6.9 kilometers to the east/ southeast). The concealed Puente Hills Blind Thrust Fault (Coyote Hills segment) along with other regional faults was included as active fault sources for the probabilistic seismic hazard analysis for the site. The approximate locations of these local and regional active faults with respect to the project site are tabulated on Table No. 1, *Summary of Regional Faults*, and are shown in Drawing No. 3, *Regional Geologic Map*, and on Drawing No. 6, *Southern California Regional Fault Map*.

The Pomona Valley Basin is bounded to the north by the San Jose Fault and to the southwest by the Chino-Central Avenue faults. These two fault systems do not exhibit evidence of surface movement within Holocene time (0-11,700 years before present) and are not considered active based on current geologic information. The San Jose and Chino-Central Avenue faults are considered Late Quaternary age, having exhibited displacement and movement within the past 738,000 years.

#### 5.1.1 San Jose Fault

The San Jose Fault lies along the southern flank of the northeast trending San Jose Hills. The fault trends northeast and dips to the north. The mapped surface trace of the San Jose Fault is located approximately 1,700 feet (0.5 kilometers) north of the project.

Geotechnical investigations performed on the campus of California State Polytechnic University at Pomona (Geocon, 2001) indicated that the San Jose fault is an active reverse separation fault. Because of the lack of success in previous fault trench excavations, Geocon based its conclusions on a series of closely spaced boreholes along several traverses across a subtle topographic bench on the campus. They discovered two shallowly to moderately north-dipping thrust faults with the most recent displacement being about 1 meter and occurred since 3500 yrs. B.P. on the basis of radiocarbon dating



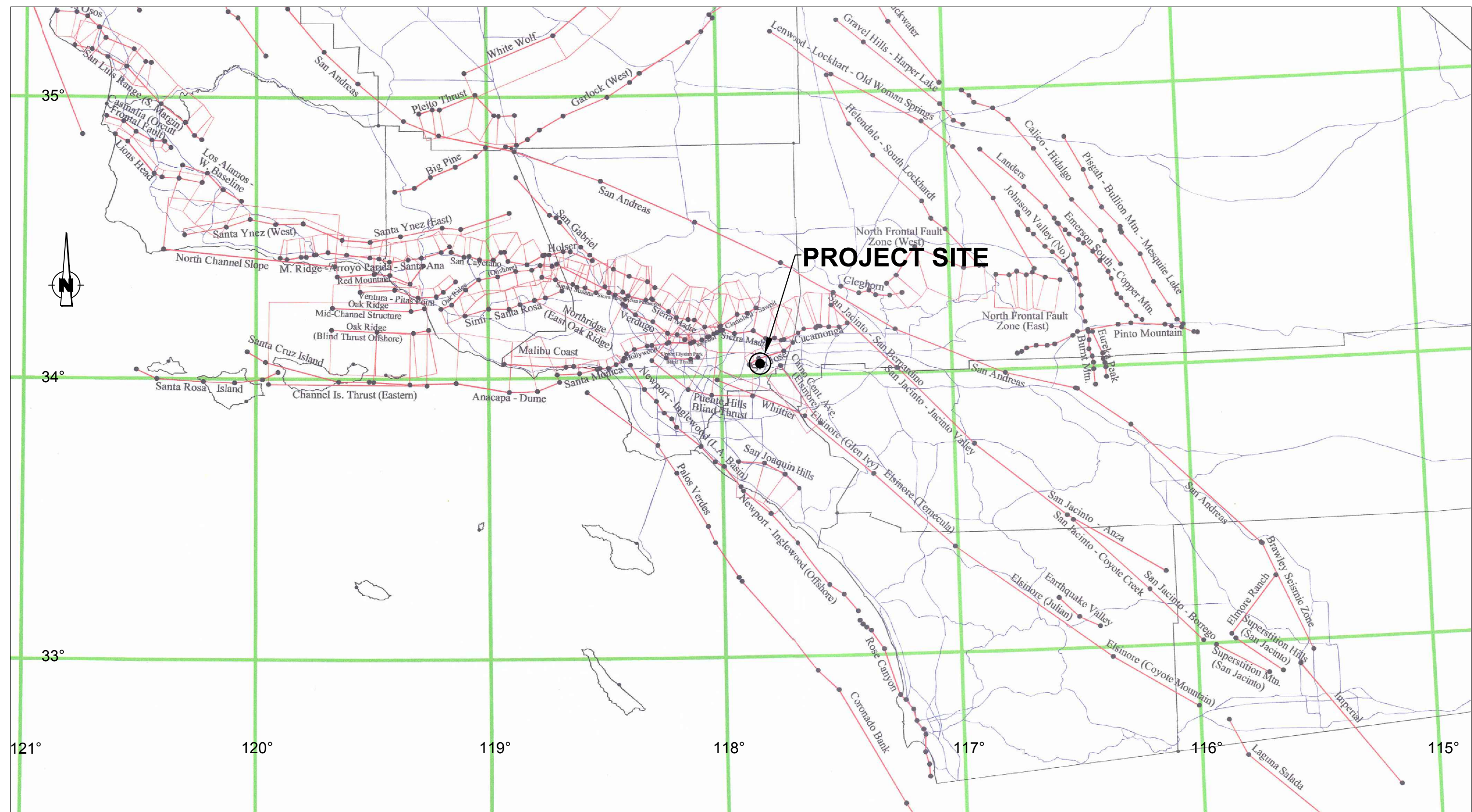

REFERENCE: PORTION OF CGS 2002 CALIFORNIA FAULT MODEL  
 MODIFIED FOR USE WITH FRISKSP AND EQFAULT  
 BY THOMAS F. BLAKE, AUGUST 2004

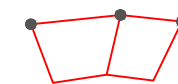
-  FAULT SOURCES
-  BLIND THRUST FAULT,  
POLYGONS INDICATE RUPTURE  
PLANES AND DIP DIRECTION

## SOUTHERN CALIFORNIA REGIONAL FAULT MAP



STUDENT CENTER BUILDING  
 MT. SAN ANTONIO COLLEGE  
 WALNUT, CALIFORNIA

Project No.  
 17-31-234-01

Drawing No.  
**6**

of faulted alluvium. These findings would show this segment of the fault is active, but is a reverse separation fault south of the San Jose Hills (Yeats, 2004).

### 5.1.2 Chino-Central Avenue Faults

The Chino and Central Avenue faults trend northwest along the southwest portion of the Chino Basin. The faults lie along the northeast edge of the Puente Hills in the cities of Chino Hills and Chino. The Chino and Central Avenue faults are considered part of the Elsinore fault system which is one of the major right lateral strike slip faults of the Peninsular Ranges geomorphic province. The Elsinore fault splits near Prado Dam into the Chino-Central Avenue and Whittier faults. The Chino-Central Avenue faults are two separate fault strands that strike northwest. The Chino fault dips southwest and is at least 18 km in length. The Central Avenue fault is about 8 km in length and concealed by younger alluvial deposits. The Chino and Central Avenue faults converge southward into the much larger Elsinore fault system.

The July 29, 2008 Chino Hills earthquake was a magnitude 5.5 earthquake event that caused moderate ground shaking and some minor damage to Mt. San Antonio College campus buildings. The earthquake epicenter was located approximately 15 miles southeast of the campus beneath the Chino Hills and at a depth of approximately 9.1 miles (14.6 km) below the ground surface.

As is the case for most areas of Southern California, ground-shaking resulting from earthquakes associated with nearby and more distant faults may occur at the project site. During the life of the project, seismic activity associated with active faults can be expected to generate moderate to strong ground shaking at the site.

Table No. 1, *Summary of Regional Faults*, summarizes selected data of known faults capable of seismic activity within 50 kilometers of the site. The data presented below was calculated using EQFAULT Version 3.0 with updated fault data from “The Revised 2002 California Probabilistic Seismic Hazard Maps (Cao et al., 2003)”, Appendix A, and other published geologic data.

**Table No. 1, Summary of Regional Faults**

Fault Name and Section	Approximate * Distance to Site (kilometers)	Max. Moment Magnitude (Mmax)	Slip Rate (mm/yr)
San Jose*	0.5	6.4	0.50
Chino-Central Ave. (Elsinore)	6.9	6.7	1.00
Elysian Park Blind Thrust*	8.2	6.7	1.50
Puente Hills Blind Thrust**	8.3	7.3	0.70
Sierra Madre*	9.6	7.2	2.00
Whittier	12.6	6.8	2.50
Cucamonga*	13.8	6.9	5.00



Fault Name and Section	Approximate * Distance to Site (kilometers)	Max. Moment Magnitude (Mmax)	Slip Rate (mm/yr)
Clamshell-Sawpit	19.5	6.5	0.50
Raymond	19.6	6.5	1.50
Verdugo*	28.6	6.9	0.50
Elsinore-Glen Ivy	29.1	6.8	5.00
Compton Thrust	29.9	6.8	1.50
Hollywood	36.2	6.4	1.00
San Jacinto – San Bernardino	38.0	6.7	12.00
San Andreas – 1857 Rupture*	39.1	7.4	30.00
San Andreas – Mojave*	39.1	7.4	30.00
Newport-Inglewood (L.A. Basin)*	39.6	7.1	1.00
San Andreas – San Bernardino*	41.0	7.5	24.00
San Andreas – Southern*	41.0	7.2	25.00
Cleghorn*	45.7	6.7	2.00
Sierra Madre (San Fernando)*	48.4	6.7	2.00

\*Review of published geologic data and mapping including Appendix A of the 2002 California Fault Parameters Report (Cao et al., 2003). Distance from the site to nearest subsurface projection, per Shaw et al., 2002.

## 5.2 Seismic History

An analysis of the seismic history of the site was conducted using the computer program EQSEARCH, (Blake, 2000), and attenuation relationships proposed by Boore et al. (1997) for alluvium soil conditions. The Southern California Earthquake Catalog with the Southern California Earthquake Center was also utilized (SCEC, 2011).

Based on the analysis of seismic history, the number of earthquakes with a moment magnitude of 5.0 or greater occurring within a distance of 100 kilometers was 169, since the year 1800. Based on the analysis, the largest earthquake-induced ground acceleration affecting the site since the year 1800 is a 7.0 magnitude earthquake in 1858 with a calculated ground acceleration of 0.24g at the site.

Review of recent seismological and geophysical publications indicates that the seismic hazard for the Pomona Basin is high. The Pomona Basin is bounded by active regional faults on all sides and underlain by alluvial sediments and buried thrust faults. The seismic hazard for the heavily populated Pomona Basin was illustrated by the 1971 San Fernando, 1987 Whittier Narrows, 1991 Sierra Madre, 1994 Northridge and July 2008 Chino Hills earthquakes. The epicenters for these earthquakes are shown in Drawing No. 7, *Epicenter Map of Southern California Earthquakes (1800-1999)*.



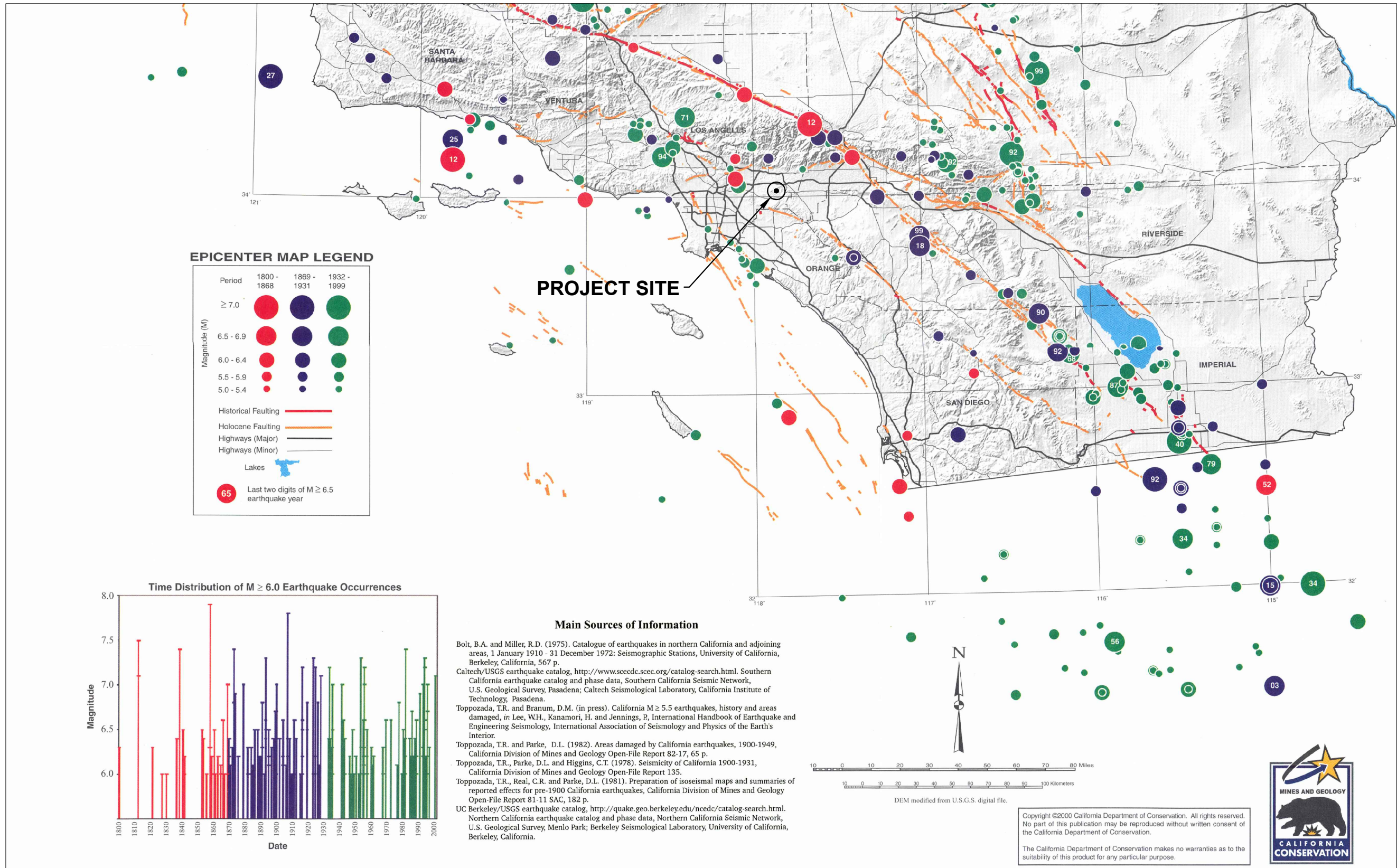

REFERENCE: PORTION OF EPICENTERS AND AREAS DAMAGED BY M ≥ 6.0 CALIFORNIA EARTHQUAKES, 1800-1999 CALIFORNIA DEPARTMENT OF CONSERVATION, MAP SHEET 49 DATED 2000.

**EPICENTER MAP OF SOUTHERN CALIFORNIA EARTHQUAKES (1800-1999)**



STUDENT CENTER BUILDING  
 MT. SAN ANTONIO COLLEGE  
 WALNUT, CALIFORNIA

Project No.  
 17-31-234-01

Drawing No.  
 7

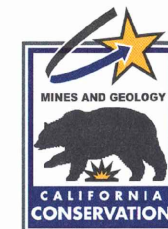

Copyright ©2000 California Department of Conservation. All rights reserved. No part of this publication may be reproduced without written consent of the California Department of Conservation. The California Department of Conservation makes no warranties as to the suitability of this product for any particular purpose.

### **5.3 Surface Fault Rupture**

The project site is not located within a currently designated State of California Earthquake Fault Zone (formerly Alquist-Priolo Special Studies Zones) for surface fault rupture. The Alquist-Priolo Earthquake Fault Zoning Act requires the California Geological Survey to zone “active faults” within the State of California. An “active fault” has exhibited surface displacement with Holocene time (within the last 11,000 years) hence constituting a potential hazard to structures that may be located across it. Public school structures are required to be set-back at least 50 feet from an active fault trace. The active fault set-back distance is measured perpendicular from the dip of the fault plane. Based on a review of existing geologic information, no known active faults project through or toward the site. The potential for surface rupture resulting from the movement of the nearby major faults is considered remote.

### **5.4 Liquefaction and Seismically-Induced Settlement**

Liquefaction is the sudden decrease in the strength of cohesionless soils due to dynamic or cyclic shaking. Saturated soils behave temporarily as a viscous fluid (liquefaction) and, consequently, lose their capacity to support the structures founded on them. The potential for liquefaction decreases with increasing clay and gravel content, but increases as the ground acceleration and duration of shaking increase. Liquefaction potential has been found to be the greatest where the groundwater level and loose sands occur within 50 feet of the ground surface.

The site is located within a potential liquefaction zone per the State of California Seismic Hazard Zones Map for the San Dimas Quadrangle as shown in Drawing No. 8, *Seismic Hazard Zones Map*. Liquefaction analysis was performed using *LiquefyPro*, Version 5.8n, 2012, by Civil Tech Software for the upper 50 feet below ground surface utilizing BH-1. The results of the liquefaction analysis and a summary of the methods used are presented in Appendix C, *Liquefaction/Seismic Settlement Analysis*.

The results of liquefaction analyses indicate the site soils are not susceptible to liquefaction. The estimated potential seismically induced settlement for BH-1 and BH-5 are 1.55-inches and 1.67-inches, respectively. The estimated potential differential settlement for BH-1 and BH-5 are 0.78-inch and 0.84-inch, respectively.

### **5.5 Lateral Spreading**

Seismically induced lateral spreading involves primarily lateral movement of earth materials due to ground shaking. It differs from the slope failure in that complete ground failure involving large movement does not occur due to the relatively smaller gradient of the initial ground surface. Lateral spreading is demonstrated by near-vertical cracks with predominantly horizontal movement of the soil mass involved. The topography at the project site and in the immediate vicinity of the site is gently sloping to the south, with no



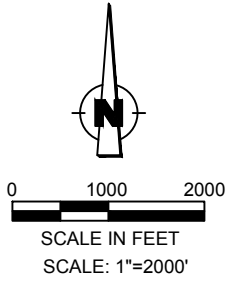

REFERENCE: EARTHQUAKE ZONES OF REQUIRED INVESTIGATION, CALIFORNIA GEOLOGICAL SURVEY, SAN DIMAS QUADRANGLE, SEISMIC HAZARD ZONE 1999

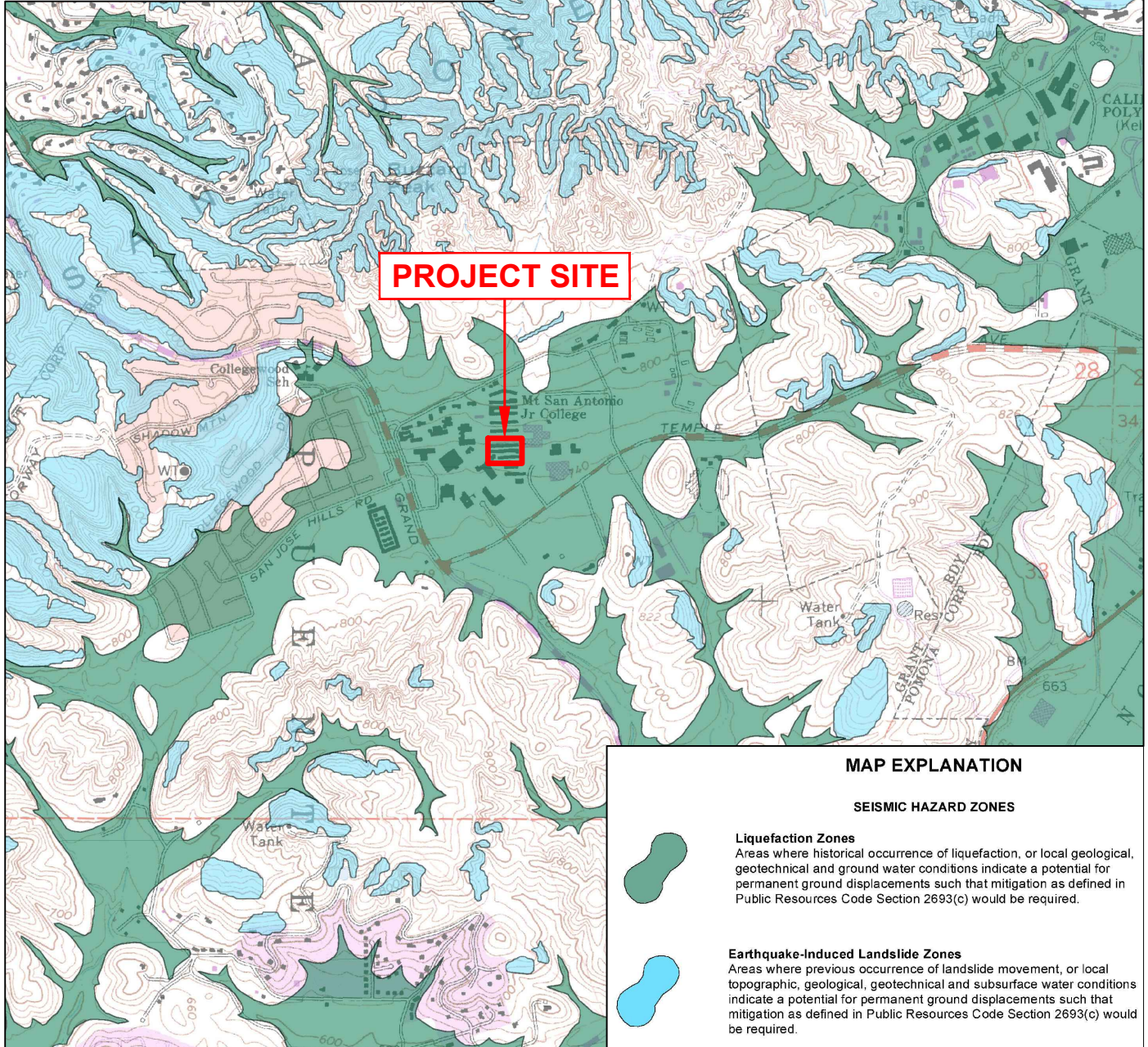
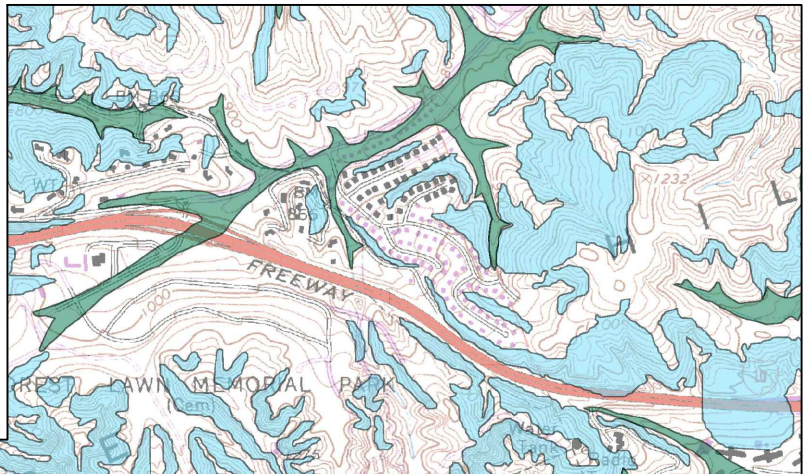

**MAP EXPLANATION**

**SEISMIC HAZARD ZONES**

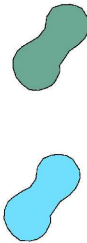

**Liquefaction Zones**  
Areas where historical occurrence of liquefaction, or local geological, geotechnical and ground water conditions indicate a potential for permanent ground displacements such that mitigation as defined in Public Resources Code Section 2693(c) would be required.

**Earthquake-Induced Landslide Zones**  
Areas where previous occurrence of landslide movement, or local topographic, geological, geotechnical and subsurface water conditions indicate a potential for permanent ground displacements such that mitigation as defined in Public Resources Code Section 2693(c) would be required.

**SEISMIC HAZARD ZONES MAP**



significant nearby slopes or embankments. Under these circumstances, the potential for lateral spreading at the subject site is considered negligible.

### **5.6 Seismically-Induced Slope Instability**

Seismically induced landslides and other slope failures are common occurrences during or soon after earthquakes. The project site is not shown with any earthquake-induced landslide areas due to the gently, southward sloping ground condition of the site topography.

### **5.7 Earthquake-Induced Flooding**

Review of the Flood Insurance Rate Map (FIRM), Map Number 0637C1725F, Panel 1725 of 2350, dated September 26, 2008, from the FEMA Map Service Center Viewer, indicates that the site is in an area designated as Zone D, "Areas in which flood hazards are undetermined, but possible." Due to the absence of groundwater at shallow depths, distance of the subject site from large bodies of water and regional flood control structures, the potential for flooding at the subject site is considered remote.

The potential of earthquake induced flooding of the subject site is considered to be remote.

### **5.8 Tsunami and Seiches**

Tsunamis are seismic sea waves generated by fault displacement or major ground movement. Based on the location of the site from the ocean (over 40 kilometers), tsunamis do not pose a hazard. Seiches are large waves generated in enclosed bodies of water in response to ground shaking. Based on site location away from lakes and reservoirs, seiches do not pose a hazard to the project site.

### **5.9 Volcanic Eruption Hazard**

There are no known volcanoes near the site. According to Jennings (1994), the nearest potential hazards from future volcanic eruptions is the Amboy Crater-Lavic Lake area located in the Mojave Desert more than 120 miles east/northeast of the site. Volcanic eruption hazards are not present.

## 6.0 SEISMIC ANALYSIS

### 6.1 CBC Seismic Design Parameters

Seismic parameters based on the 2016 California Building Code are calculated using the United States Geological Survey *U.S. Seismic Design Maps* website application and the site coordinates (34.04696 degrees North Latitude, -117.84507 degrees West Longitude). The seismic parameters are presented below:

**Table No. 2, CBC Seismic Design Parameters**

Seismic Parameters	2016 CBC
Site Class	D
Mapped Short period (0.2-sec) Spectral Response Acceleration, $S_s$	2.182 g
Mapped 1-second Spectral Response Acceleration, $S_1$	0.779
Site Coefficient (from Table 1613.5.3(1)), $F_a$	1.0
Site Coefficient (from Table 1613.5.3(2)), $F_v$	1.5
MCE 0.2-sec period Spectral Response Acceleration, $S_{MS}$	2.182 g
MCE 1-second period Spectral Response Acceleration, $S_{M1}$	1.169 g
Design Spectral Response Acceleration for short period, $S_{DS}$	1.454 g
Design Spectral Response Acceleration for 1-second period, $S_{D1}$	0.779 g

### 6.2 Site-Specific Response Spectra

A site-specific response spectrum was developed for the project for a Maximum Considered Earthquake (MCE), defined as a horizontal peak ground acceleration that has a 2 percent probability of being exceeded in 50 years (return period of approximately 2,475 years). The controlling source was determined to be the USGS 2008 California Gridded Source, with an MCE of Mw 7.0 and a deterministic peak ground acceleration (PGA) of 1.088g.

In accordance with ASCE 7-10, Section 21.2 the site-specific response spectra can be taken as the lesser of the probabilistic maximum rotated component of MCE ground motion and the 84<sup>th</sup> percentile of deterministic maximum rotated component of MCE ground motion response spectra. The design response spectra can be taken as 2/3 of site-specific MCE response spectra, but should not be lower than 80 percent of CBC general response spectra. The risk coefficient  $C_R$  has been incorporated at each spectral response period for which the acceleration was computed in accordance with ASCE 7-10, Section 21.2.1.1.

The 2016 CBC mapped acceleration parameters are provided in the following table. These parameters were determined using the United States Geological Survey *U.S. Seismic Design Maps* website application, and in accordance with ASCE 7-10 Sections 11.4, 11.6, 11.8 and 21.2.

**Table No. 3, 2016 CBC Mapped Acceleration Parameters**

Site Class	D	Seismic Design Category	D
<b>S<sub>s</sub></b>	2.184	<b>C<sub>RS</sub></b>	1.012
<b>S<sub>1</sub></b>	0.780	<b>C<sub>R1</sub></b>	1.022
<b>F<sub>a</sub></b>	1	<b>0.08 F<sub>v</sub>/F<sub>a</sub></b>	0.120
<b>F<sub>v</sub></b>	1.5	<b>0.4 F<sub>v</sub>/F<sub>a</sub></b>	0.600
<b>S<sub>MS</sub></b>	2.184	<b>T<sub>0</sub></b>	0.107
<b>S<sub>M1</sub></b>	1.170	<b>T<sub>s</sub></b>	0.536
<b>S<sub>DS</sub></b>	1.456	<b>T<sub>L</sub></b>	8
<b>S<sub>D1</sub></b>	0.780		

A Site-Specific response analysis, using faults within 200 kilometers of the sites, was developed using the computer program EZ-FRISK by Risk Engineering (v. 7.62) and the 2008 USGS Fault Model database. Attenuation relationships proposed by Boore and Atkinson (2008), Campbell and Bozorgnia (2008), Chiou and Youngs (2008) were used in the analysis. These attenuation relationships are based on Next Generation Attenuation (NGA) project model. Maximum rotated components were determined using Huang (2008) method. An average shear wave velocity at upper 30 meters of soil profile ( $V_{s30}$ ) of 360 meters per second, depth to bedrock of with a shear wave velocity 1,000 meters per second at 150 meters below grade, and depth of bedrock where the shear wave velocity is 2,500 meters per second at 3,000 meters below grade were selected for EZ-Frisk Analysis.

The probabilistic response spectrum results and peak ground acceleration for each attenuation relationship are presented in the following table.

**Table No. 4, Probabilistic Response Spectrum Data**

Attenuation Relationship	Boore-Atkinson (2008)	Campbell-Bozorgnia (2008)	Chiou-Youngs (2007)	Probabilistic Mean
<b>Peak Ground Acceleration (g)</b>	0.934	0.910	1.059	0.975
Spectral Period (sec)	2% in 50yr Probabilistic Spectral Acceleration (g)			
0.03	1.012	0.974	1.139	1.047
0.05	1.119	1.119	1.308	1.187
0.10	1.598	1.605	1.869	1.696
0.20	2.025	2.051	2.313	2.135
0.30	2.000	1.916	2.213	2.053
0.40	1.932	1.796	2.032	1.925
0.50	1.830	1.711	1.870	1.804
0.75	1.506	1.392	1.487	1.463
1.00	1.202	1.159	1.242	1.201

Spectral Period (sec)	2% in 50yr Probabilistic Spectral Acceleration (g)			
2.00	0.639	0.608	0.571	0.608
3.00	0.426	0.398	0.356	0.395
4.00	0.305	0.304	0.253	0.290

Applicable response spectra data are presented in the table below and on Drawing No. 9, *Site-Specific Design Response Spectrum*. These curves correspond to response values obtained from above attenuation relations for horizontal elastic single-degree-of-freedom systems with equivalent viscous damping of 5 percent of critical damping.

**Table No. 5, Site-Specific Response Spectrum Data**

Period (sec)	2% in 50yr Probabilistic Spectral Acceleration (g)	Risk Coefficient $C_R$	Probabilistic MCE <sub>R</sub> Spectral Acceleration (g)	84th Percentile Deterministic MCE Response Spectra, (g)	Deterministic CBC Lower Level, (g)	Site Specific MCE <sub>R</sub> Spectral Acceleration (g)	80% CBC Design Response Spectrum	Site Specific Design Spectral Acceleration (g)
0.03	1.047	1.012	1.060	1.181	0.225	1.060	0.662	<b>0.71</b>
0.05	1.187	1.012	1.201	1.338	0.375	1.201	0.792	<b>0.80</b>
0.10	1.696	1.012	1.716	1.808	0.750	1.716	1.118	<b>1.14</b>
0.20	2.135	1.012	2.161	2.296	1.500	2.161	1.165	<b>1.44</b>
0.30	2.053	1.013	2.080	2.347	1.500	2.080	1.165	<b>1.39</b>
0.40	1.925	1.015	1.953	2.327	1.500	1.953	1.165	<b>1.30</b>
0.50	1.804	1.016	1.832	2.236	1.500	1.832	1.165	<b>1.22</b>
0.75	1.463	1.019	1.491	1.877	1.200	1.491	0.832	<b>0.99</b>
1.00	1.201	1.022	1.227	1.502	0.900	1.227	0.624	<b>0.82</b>
2.00	0.608	1.022	0.621	0.719	0.450	0.621	0.312	<b>0.41</b>
3.00	0.395	1.022	0.404	0.431	0.300	0.404	0.208	<b>0.27</b>
4.00	0.290	1.022	0.296	0.310	0.225	0.296	0.156	<b>0.20</b>

The site-specific design response parameters are provided in the following table. These parameters were determined from Design Response Spectra presented in table above, and following guidelines of ASCE Section 21.4.

**Table No. 6, Site-Specific Seismic Design Parameters**

Parameters	Value (5% Damping)	Lower Limit, 80% of CBC Design Spectra
Site-Specific 0.2-second period Spectral Response Acceleration, $S_{MS}$	2.161	1.747
Site-Specific 0.1-second period Spectral Response Acceleration, $S_{M1}$	1.243	0.936
Site-Specific Design Spectral Response Acceleration for short period $S_{DS}$	1.440	1.165
Site-Specific Design Spectral Response Acceleration for 1-second period, $S_{D1}$	0.828	0.624



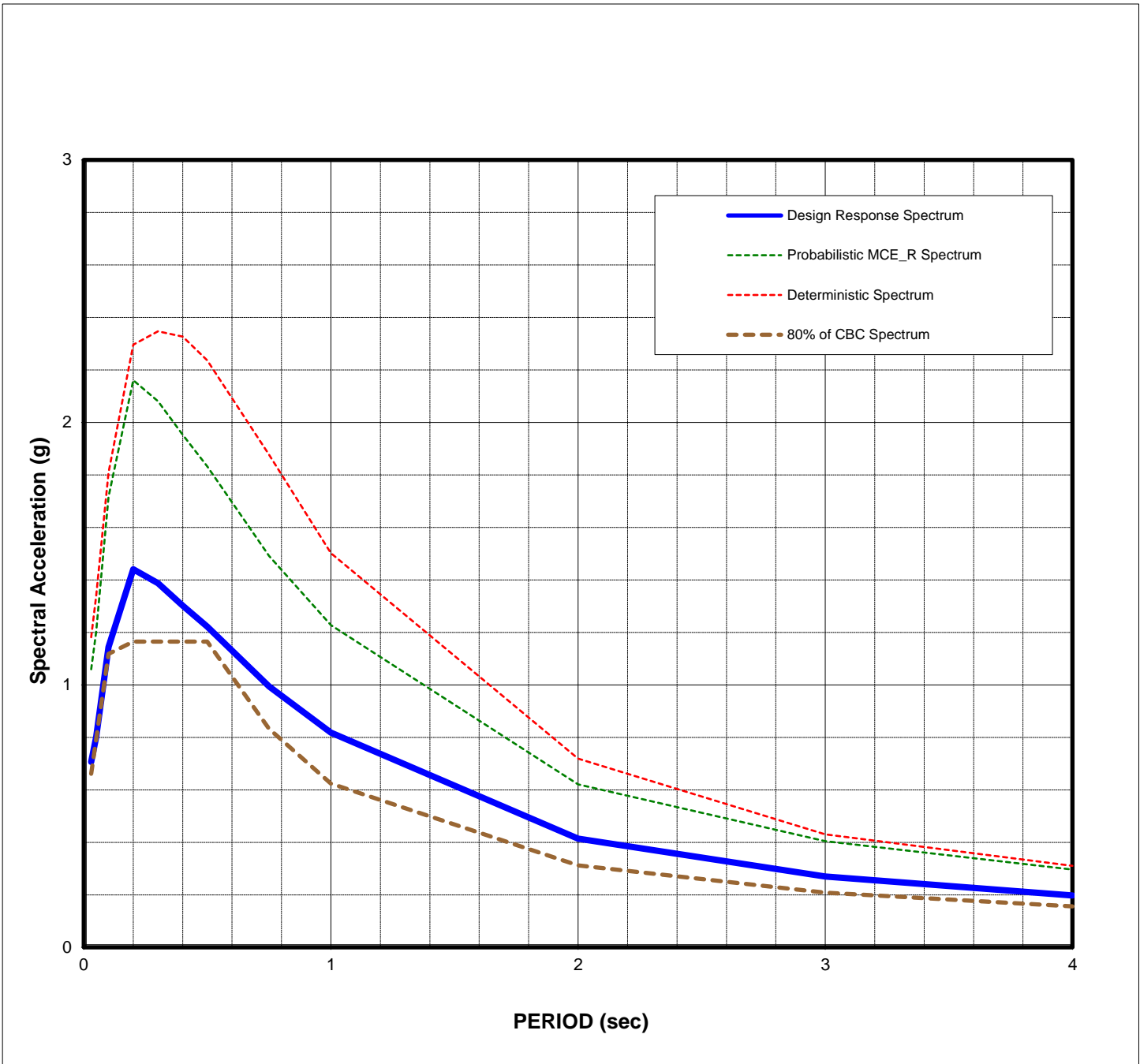

Note: Calculated using EZFRISK program Risk Engineering, version 7.62 and USGS 2008 fault model database.

**SITE-SPECIFIC DESIGN RESPONSE SPECTRUM**

Mt. SAC Student Center  
 1100 N. Grand Avenue, Walnut, CA 91789  
 For : Mt. San Antonio College

Project Number:  
 17-31-234-01



**Converse Consultants**

Drawing No.

9

## 7.0 GEOTECHNICAL EVALUATIONS AND CONCLUSIONS

Based on the results of our background review, subsurface exploration, laboratory testing, geotechnical analyses, and understanding of the planned site development, it is our opinion that the proposed project is feasible from a geotechnical standpoint, provided the following conclusions and recommendations are incorporated into the project plans, specifications, and are followed during site construction.

The following is a summary of the major geologic and geotechnical factors to be considered for the planned project:

- Undocumented fills, approximately three to five feet in thickness, were encountered in the borings. Deeper artificial fill may exist at the site. The fill encountered consists primarily of silty sand, clayey sand, sandy clay, and silty clayey sand. The natural alluvial soil deposits below the surface fills primarily consists of fine grained clays, clayey sand, silty sand, silt, and sandy silt.
- Groundwater was encountered during the time of drilling in Boring BH-5 at a depth of approximately 47.5 feet bgs.
- The project site is not located within a currently designated State of California Earthquake Fault Zone (formerly Alquist-Priolo Special Studies Zones) for surface fault rupture. The Alquist-Priolo Earthquake Fault Zoning Act requires the California Geological Survey to zone “active faults” within the State of California. The site can be expected to receive moderate to strong ground shaking from earthquakes on local and regional faults.
- The site is located within a potential liquefaction zone per the State of California Seismic Hazard Zones Map for the San Dimas Quadrangle. The results of liquefaction analyses indicate the site soils are not susceptible to liquefaction. The estimated potential seismically induced settlement for BH-1 and BH-5 are 1.55-inches and 1.67-inches, respectively. The estimated potential differential settlement for BH-1 and BH-5 are 0.78-inch and 0.84-inch, respectively.
- Based on the field investigation, the near-surface earth materials are primarily silty sand, clayey sand, and silt. The site soils were tested for expansion potential per ASTM Standard D4829 and were found to have “very low” expansion potential
- In accordance with the Caltrans Corrosive Guidelines (2015), water soluble sulfates in the soil indicate that concrete exposed has no restrictions on cement type or water-cement ratio. The pH, chloride concentrations, resistivity, and sulfate concentrations fall in the “non-corrosive” range for structural elements.

- Percolation testing was performed utilizing exploratory boring BH-4 on August 24, 2017. The test resulted in an average percolation rate of 1.74 inches/hour and a lowest percolation rate of 1.35 inches/hour
- Thicknesses of flexible pavement structural sections were calculated using a laboratory obtained R-Value of 17. The recommended flexible pavement structural sections for various TI conditions are presented in Table No. 11, *Flexible Pavement Structural Sections*.
- Based on our field exploration, the earth materials at the site should be excavatable with conventional heavy-duty earth moving and trenching equipment
- We recommend the proposed new Student Center Building be supported on shallow spread foundations provided our earthwork recommendations are incorporated in the design and construction.

## **8.0 DESIGN RECOMMENDATIONS**

### **8.1 General Evaluation**

Based on the results of our background review, subsurface exploration, laboratory testing, geotechnical analyses, and understanding of the planned site development, it is our opinion that the proposed project is feasible from a geotechnical standpoint, provided the following conclusions and recommendations are incorporated into the project plans, specifications, and are followed during site construction.

### **8.2 Shallow Foundations**

The proposed new student center building can be supported on shallow continuous and isolated spread foundations founded on compacted fill provided our recommendations and earthwork recommendations are incorporated in the design and construction. These foundations can be tied using grade beams to reduce the differential settlement, if needed.

#### 8.2.1 Vertical Capacity

The proposed new Student Center Building can be supported by conventional shallow footings. We recommend continuous and square footings be founded at least 24 inches below lowest adjacent final grade entirely into compacted fill or into native soil. A minimum footing width of 24 inches is recommended for square footings and 18 inches for continuous footings. The allowable bearing value for footings with above minimum sizes founded on compacted fill and competent native soils may be designed for a net bearing pressure of 2,000 pounds per square foot (psf) for dead-plus-live-loads. The net allowable bearing pressure can be increased by 500 psf for each additional foot of excavation depth and by 250 psf for each additional foot of excavation width up to a maximum value of 4,000 psf.

The net allowable bearing values indicated above are for the dead loads and frequently applied live loads and are obtained by applying a factor of safety of 3.0 to the net ultimate bearing capacity.

#### 8.2.2 Lateral Capacity

Resistance to lateral loads can be provided by friction acting at the base of the foundation and by passive earth pressure. A coefficient of friction of 0.30 may be assumed with normal dead load forces. An allowable passive earth pressure of 240 psf per foot of depth up to a maximum of 2,400 psf may be used for footings poured against properly compacted fill. The values of coefficient of friction and allowable passive earth pressure include a factor of safety of 1.5.

### 8.2.3 Settlement

The static settlement of structures supported on continuous and/or spread footings founded on compacted fill will depend on the actual footing dimensions and the imposed vertical loads. Most of the footing settlement at the project site is expected to occur immediately after the application of the load. Based on the maximum allowable net bearing pressures presented above, static settlement is anticipated to be less than one (1) inch. Differential settlement is expected to be up to one-half of the total settlement over a 30-foot span.

The estimated potential seismically induced settlement for BH-1 and BH-5 are 1.55-inches and 1.67-inches, respectively. The estimated potential differential settlement for BH-1 and BH-5 are 0.78-inch and 0.84-inch, respectively. These foundations can be tied using grade beams to reduce the differential settlement, if needed.

### 8.2.4 Dynamic Increases

Bearing values indicated above are for total dead load and frequently applied live loads. The above vertical bearing may be increased by 33% for short durations of loading which will include the effect of wind or seismic forces. The allowable passive pressure may be increased by 33% for lateral loading due to wind or seismic forces.

## **8.3 Slabs-on-Grade**

Slabs-on-grade should be supported on properly compacted fill. Compacted fill used to support slabs-on-grade should be placed and compacted in accordance with report Section 9.0, *Earthwork Recommendations*.

Slabs-on-grade should have a minimum thickness of five (5) inches nominal for support of normal ground-floor live loads. Minimum reinforcement for slabs-on-grade should be No. 4 reinforcing bars, spaced at 18 inches on-center each way. The thickness and reinforcement of more heavily-loaded slabs will be dependent upon the anticipated loads and should be designed by a structural engineer. A static modulus of subgrade reaction equal to 150 pounds per square inch per inch may be used in structural design of concrete slabs-on-grade.

It is critical that the exposed subgrade soils should not be allowed to desiccate prior to the slab pour. Care should be taken during concrete placement to avoid slab curling. Slabs should be designed and constructed as promulgated by the ACI and Portland Cement Association (PCA). Prior to the slab pour, all utility trenches should be properly backfilled and compacted.

If moisture-sensitive floor coverings, such as vinyl tile, carpet, or wood floors, are used, slabs should be underlain by a minimum 10-mil thick moisture retarder/barrier in conformance with ASTM E 1745 Class A requirements.



#### 8.4 Modulus of Subgrade Reaction

For the subject project, design of the structures supported on compacted fill subgrade prepared in accordance with the recommendations provided in this report may be based on a soil modulus of subgrade reaction of ( $k_s$ ) of 150 pounds per square inch per inch.

#### 8.5 Lateral Earth Pressure

The following provisional design values may be used for any utility vaults and/or walls below grade that are less than six (6) feet high.

The earth pressure behind any buried wall depends primarily on the allowable wall movement, type of soil behind the wall, backfill slopes, wall inclination, surcharges, and any hydrostatic pressure. The following earth pressures are recommended for vertical walls with no hydrostatic pressure.

**Table No. 7, Lateral Earth Pressures for Retaining Wall Design**

Backfill Slope (H:V)	Cantilever Wall Equivalent Fluid Pressure (pcf)	Restrained Wall Equivalent Fluid Pressure (psf)
Level	40 (triangular pressure distribution)	60 (triangular pressure distribution)

The recommended lateral pressures assume that the walls are fully back-drained to prevent build-up of hydrostatic pressure. Suitable subdrain systems should be installed around the perimeter of the subterranean walls enclosing interior spaces and moisture sensitive areas to provide adequate drainage and prevent water buildup behind the retaining walls and beneath the bottom floor level. Adequate drainage should be provided by means of permeable drainage materials wrapped in filter fabric installed behind the walls. The drainage system should consist of perforated pipe surrounded by a minimum one (1) square foot per lineal feet of free draining, uniformly graded, ¾-inch washed, crushed aggregate, and wrapped in filter fabric such as Mirafi 140N or equivalent. The filter fabric should overlap approximately 12 inches or more at the joints. The subdrain pipe should consist of perforated, four-inch diameter, rigid Schedule 40 PVC or ABS (SDR-35), with perforations placed down. Alternatively, a prefabricated drainage composite system such as the Miradrain G100N or equivalent can be used. The subdrain should be connected to solid pipe outlets with glued manufactured pipe fittings, couplings and caps and sloped at a minimum 1-2% gradient to provide gravity flow to a suitable disposal point. The subdrain should be continuous around the perimeter of the wall footing and discharge into a suitable, non-erosive drain outlet with the maximum outlet spacing of 100 feet to a suitable disposal points. Subdrain systems and surface drains systems should be kept separate to prevent recharging of surface water behind the walls.

Subterranean walls and floor levels that retain earth and enclose interior spaces and floors should be waterproofed and dampproofed for moisture sensitive areas to mitigate

potential moisture migration through the walls and floor slabs. Adequate ventilation of the subterranean floor levels should be provided. Waterproofing of the foundation walls and floor slabs should be performed in accordance with Chapter 18-Soils and Foundations, Section 1805-Damproofing and Waterproofing of the 2014 County of Los Angeles Building Code.

In addition, walls with inclined backfill should be designed for an additional equivalent fluid pressure of one (1) pound per cubic foot for every two (2) degrees of slope inclination. Walls subjected to surcharge loads located within a distance equal to the height of the wall should be designed for an additional uniform lateral pressure equal to one-third (1/3) or one-half (1/2) the anticipated surcharge load for unrestrained or restrained walls, respectively. These values are applicable for backfill placed between the wall stem and an imaginary plane rising 45 degrees from below the edge (heel) of the wall footings.

Retaining walls taller than six (6) feet should be designed to resist additional earth pressure caused by seismic ground shaking based on Section 1615A.1.6 of CBC 2010. A seismic earth pressure 20H (psf), based on an inverted triangular distribution, can be used for design of wall.

Basement walls can be designed using at-rest pressures provided in Table No. 7, *Lateral Earth Pressures for Retaining Wall Design*. The seismic earth pressure does not need to be added to the at-rest pressures for the basement retaining wall design.

### 8.6 Soil Corrosivity Evaluation

Converse retained the Environmental Geotechnology Laboratory, Inc., located in Arcadia, California, to test two (2) samples taken in the general area of the proposed structure. The tests included minimum resistivity, pH, soluble sulfates, and chloride content, with the results summarized in the following table:

**Table No. 8, Soil Corrosivity Test Results**

Boring No.	Sample Depth (feet)	pH (Caltrans 643)	Soluble Chlorides (Caltrans 422) ppm	Soluble Sulfate (Caltrans 417) % by Weight	Saturated Resistivity (Caltrans 532) Ohm-cm
BH-1	0-5.0	6.78	145	0.014	2,700
BH-9	0-5.0	7.16	240	0.019	2,200

In accordance with the Caltrans Corrosive Guidelines (2015), water soluble sulfates in the soil indicate that concrete exposed has no restrictions on cement type or water-cement ratio. The pH, chloride concentrations, resistivity, and sulfate concentrations fall in the “non-corrosive” range for structural elements.

In general, conventional corrosion mitigation measures may include the following:

- Steel and wire concrete reinforcement should have at least three inches of concrete cover where cast against soil, unformed.
- Below-grade ferrous metals should be given a high-quality protective coating, such as 18-mil plastic tape, extruded polyethylene, coal-tar enamel, or Portland cement mortar.
- Below-grade metals should be electrically insulated (isolated) from above-grade metals by means of dielectric fittings in ferrous utilities and/or exposed metal structures breaking grade.

The test results presented herein are considered preliminary. If advanced corrosivity study is desired by the design team, a corrosion engineer can be consulted for appropriate mitigation procedures and construction design.

### **8.7 Percolation Testing**

Percolation testing was performed utilizing exploratory boring BH-4 on August 24, 2017. The tests were performed using the falling head test method in accordance with Los Angeles County “Low Impact Development Best Management Practice Guideline for Design, Investigation, and Reporting”.

The result of the percolation test can be seen below and in Appendix E, *Percolation Testing*.

**Table No. 9, Boring Percolation Test Result**

Boring No.	Depth of Test (feet)	Soil Types (USCS)	Average Percolation Rate (inches/hour)	Lowest Percolation Rate (inches/hour)
BH-4	0.0-10.0	Silt (ML) over Sandy Silt (ML)	1.74	1.35

In accordance with County of Los Angeles requirements, the minimum percolation rate for design of infiltration system for storm water management is 0.3 inch per hour. The project Civil Engineer shall review the data of percolation test presented in Appendix E to determine specific soil layers and percolation rates for design of the proposed infiltration system. Infiltration system should be properly maintained periodically to minimize sedimentation in the infiltration system. A proposed infiltration system must comply with the following setbacks in accordance with Los Angeles County guideline.

**Table No. 10, Infiltration Facility Setback Requirements per Los Angeles County**

Setback from	Distance
Property lines and public right of way	5 feet
Any foundation	15 feet or within 1:1 plane drawn up from the bottom of foundation, whichever greater
Face of any slope	H/2, 5 feet minimum (H is height of slope)
Water wells used for drinking water	100 feet
Historically highest groundwater levels	10 feet above

### 8.8 Flexible Pavement Design

The flexible pavement structural section design recommendations were performed in accordance with the method contained in the *CALTRANS Highway Design Manual*, Chapter 630 with a safety factor of 0.2 for asphalt concrete over aggregate base and 0.1 for a full depth asphalt concrete section. No specific traffic study was performed to determine the Traffic Index (TI) for the proposed project, therefore a wide range of TI values was evaluated. Thicknesses of flexible pavement structural sections were calculated using a laboratory obtained R-Value of 17. The recommended flexible pavement structural sections for various TI conditions are presented in the following table:

**Table No. 11, Flexible Pavement Structural Sections**

Design R-value	Design TI	AC over AB Structural Section		Full Section AC
		AC (inches)	AB (inches)	
17	4	4.0	4.0	5.0
	5	4.0	8.0	7.0
	6	5.0	9.5	8.5
	7	6.0	11.5	10.0
	8	7.0	13.0	11.5
	9	8.0	14.5	13.0

Actual traffic index and traffic load should be determined by either a Civil Engineer or Traffic Engineer. The above pavement sections are recommended as a guideline for basic usage of the indicated TI values, and may not be sufficient for actual traffic loading.

Base material shall conform to requirements for a Class 2 Aggregate Base (AB) or equivalent (such as crushed miscellaneous base (CMB)) and should be placed in accordance with the requirements of the Standard Specifications for Public Works Construction (SSPWC, Latest Edition).

Asphaltic materials should conform to Section 203-1, "*Paving Asphalt*," and should be placed in accordance with Section 302-5, "*Asphalt Concrete Pavement*," of the SSPWC.

We recommend the subgrade pavement areas be over-excavated and recompacted at least 2 feet below existing soil subgrade where space and buried utility lines permit. If

loose, soft, yielding soil conditions are encountered at the excavation bottom, then additional mitigation measures should be considered including deeper removal and re-compaction of site soils, bridging soft bottoms with imported base materials and/or placement of a geofabric layer to reinforce the soil subgrade. The soil subgrade materials should be processed, mixed, moisture conditioned as needed to near optimum moisture content, and compacted to at least 90 percent of the laboratory maximum dry density (ASTM Standard D1557). Imported base materials should be compacted to at least 95 percent relative compaction.

### **8.9 Site Drainage**

Adequate positive drainage should be provided away from the structures to prevent ponding and to reduce percolation of water into structural backfill. We recommend that the landscape area immediately adjacent to the foundation shall be designed sloped away from the building with a minimum 5% slope gradient for at least 10 feet measured perpendicular to the face of the wall. Impervious surfaces within 10 feet of the foundation shall have a minimum 2 percent slope away from the building per 2016 CBC.

Planters and landscaped areas adjacent to the building perimeter should be designed to minimize water infiltration into the subgrade soils.

### **8.10 Slope Maintenance and Erosion Control**

Existing slopes and landscaped areas require periodic inspections and maintenance for proper upkeep and to help assure their continued stability. Most soil erosion problems are associated with water and site drainage. Maintaining adequate positive drainage and slope planting is important for erosion control. Drainage related items requiring periodic inspection and maintenance include:

- Compacted earth berms, side swales, and non-erosive drainage devices should be installed to prevent water from flowing uncontrolled over the tops of slopes and walls. It is important that these devices be maintained and free of obstruction.
- Periodic inspections of the slope areas, interceptor drains, terrace drains and down drains should be performed to check for proper operation. These drainage devices should be checked before the winter rainy season and before and after major storms.
- Interceptor drains, terrace drains, down drains, drain pipes, catch basins and drainage devices should be kept clean of debris and maintained in good working order to provide adequate drainage for slope areas. Control joints and cracks in concrete or asphalt drainage devices should be sealed and/or resealed to prevent infiltration of water into slope soils. The drainage devices should be routinely checked for proper operation and cleared of silt and debris.



- Rodent activity should be controlled to prevent loosening of soils and water penetration. Animal burrows should be filled with compacted soils since they may cause diversion of surface runoff, promote accelerated erosion, or cause shallow slope failures.
- Slope areas disturbed by foot traffic, trails, erosion and gullies should be repaired with compacted soils and re-planted to prevent slope erosion. Site users should be encouraged to use designated trails, pathways, stairways and service roads for access.
- Slope planting should be maintained for erosion control. Nylon and jute netting can be used to protect and maintain exposed slope surfaces until a dense growth of vegetation has been established. Graded slopes may require more time to establish plant growth. The optimal goal of planting is to achieve a dense growth of vegetation (which includes plants of varying root depths) requiring little watering. Bare spots, areas of little growth and areas with deteriorated mesh or plant cover, may have to re-seeded and/or replanted with new mesh and plants for erosion control. Loose soils, plant cuttings and debris should not be permitted to accumulate on the slopes.
- Landscape watering should be controlled and be just sufficient to sustain plant growth. Seasonal adjustments to the amount of watering should be performed prudently, with periodic monitoring and regulation. Slope areas should not be over-watered. Sprinkler and irrigation systems should be maintained and adjusted to prevent overwatering of slopes and landscaping. Irrigation leaks should be stopped and repaired as soon as possible to prevent wasting of water and soil erosion. Wet spots may indicate a leaking or broken water line or control valve.

## **9.0 EARTHWORK AND SITE GRADING RECOMMENDATIONS**

### **9.1 *General Evaluation***

Based on our field exploration, laboratory testing, and analyses of subsurface conditions at the site, remedial grading will be required to prepare the sites for support of the proposed structures that are constructed with conventional shallow spread footings. To reduce differential settlement, variations in the soil type, degree of compaction, and thickness of the compacted fill, the thickness of compacted fill placed underneath the footings should be kept uniform.

Site grading recommendations provided below are based on our experience with similar projects in the area and our evaluation of this investigation.

Site preparation for the proposed structures will require removal of existing structures, footings, slabs, improvements, pavements, sidewalks, trees, grass and roots, organic rich top soils and other existing underground manmade structures and utilities. Top soils containing organic rich materials are not acceptable for reuse as compacted fill soils beneath the building pad and structures.

The site soils can be excavated utilizing conventional heavy-duty earth-moving equipment. The excavated site soils, free of vegetation, shrub and debris, may be placed as compacted fill in structural areas after proper processing. Rocks larger than three (3) inches in the largest dimension should not be placed as fill.

On-site clayey soils and with an expansion index exceeding 20 should not be re-used for compaction within 2 feet below the proposed foundations. Soils containing organic materials should not be used as structural fill. The extent of removal should be determined by the geotechnical representative based on soil observation during grading.

### **9.2 *Over-Excavation***

Undocumented fill soils approximately three (3) to five (5) feet in thickness were encountered in the borings. All undocumented fill soils and unsuitable or disturbed on-site soils in the building structure area and to five (5) feet beyond the building limits and appendages should be removed and be recompacted to provide at least three (3) feet of properly compacted fill beneath the bottom of the building foundations. A minimum removal of 24 inches should be anticipated for all concrete flatwork and for minor non-load bearing and lightly loaded minor structures, the paving areas for parking and driveways. The actual depth of fill removal and re-compaction should be determined in the field during grading by the project geotechnical engineer or his representative.

The on-site soils and undocumented fill soils in the upper five (5) feet and five (5) beyond the building limits should be completely over-excavated and recompacted for building slab

and foundation support. If loose, disturbed or otherwise unsuitable soil materials are encountered at the bottom of excavations, deeper removals will be required until firm and unyielding native soils are encountered. The final bottom surfaces of all excavations shall be observed and approved by the project geotechnical engineer or his representative prior to placing any compacted fill. The bottoms should be proof rolled with a loaded, heavy, rubber tired piece of grading equipment to identify loose or soft bottom areas. All fill soils should be placed on competent native materials or properly compacted fill as determined by the project geotechnical engineer or his representative. The excavations to remove undocumented fill soils and unsuitable soils should be extended to five (5) feet beyond the proposed structure limits where space is available. Localized deeper removal will be needed where firm native soils are not exposed on the excavation bottom. For pavement, flatwork and hardscape areas, the upper 24 inches of subgrade soils should be over-excavated and recompacted.

Existing foundations, footings and utilities that are to remain in place should not be undermined during grading and construction and shall be properly supported.

The exposed bottom of the over-excavation area should be scarified at least 6 inches, moisture conditioned to above three percent (3%) of the optimum moisture content for fine-grained soils and within three percent (3%) of the optimum moisture content for granular soils, mixed and compacted to at least 90 percent (90%) relative compaction (laboratory maximum density evaluated per ASTM D1577). Over-excavation should not undermine adjacent off-site improvements. Remedial grading should not extend within a projected 1:1 (horizontal to vertical) plane projected down from the outer edge of adjacent off-site improvements. If loose, yielding soil conditions are encountered at the excavation bottom, the following options can be considered:

- a. Over-excavate until reach firm bottom.
- b. Scarify or over-excavate additional 18 inches deep, and then place at least 18-inch-thick compacted base material (CAB or equivalent) to bridge the soft bottom. Base should be compacted to 95% relative compaction.
- c. Over-excavate additional 18 inches deep, and then place a layer of geofabric i.e. Mirafi HP570, X600 or equivalent), place 18-inch-thick compacted base material (CAB or equivalent) to bridge the soft bottom. Base should be compacted to 95% relative compaction. An additional layer of geofabric may be needed on top of base depending on the actual site conditions.

The actual depth of removal should be based on recommendations and observation made during grading by the project geotechnical engineer or his representative. Therefore, some variations in the depth and lateral extent of over-excavation recommended in this report should be anticipated.

### **9.3 Structural Fill**

Following observation of the excavation bottom, subgrade soil surfaces should be scarified to a depth of at least six inches. The scarified soil should be moisture-conditioned within three (3) percent of optimum moisture for granular soils and to approximate three (3) percent above the optimum moisture for fine-grained soil. Scarified soil shall be compacted to a minimum 90 percent of the laboratory maximum dry density as determined by the ASTM Standard D1557 test method.

Any import fill should be tested and approved by project geotechnical engineer or his designated representative. The import fill should have an expansion potential less than 20. The imported materials should be thoroughly mixed and moisture conditioned within three (3) percent above the optimum moisture. All fill, if not specified otherwise elsewhere in this report, should be compacted to at least 90 percent of the laboratory maximum dry density in accordance with the ASTM Standard D1557 test method.

Where the fill is not within the areas specified above or is not to support any structures, excavated site soils, free of deleterious materials and rock particles larger than three inches in the largest dimension, should be suitable for placement as compacted fill. The site materials should be thoroughly processed, mixed and moisture conditioned to approximate three (3) percent above the optimum moisture for fine-grained soils and within three (3) percent of the optimum moisture content for granular soils, and then compacted to at least 90 percent of relative compaction.

### **9.4 Subgrade Preparation**

Final subgrade soils for proposed structures and pavement should be uniform and non-yielding. To obtain a uniform subgrade, soils should be well mixed, moisture conditioned and uniformly compacted. The subgrade soils should be properly moisture conditioned before placing concrete.

### **9.5 Excavatability**

Based on our field exploration, the earth materials at the site should be excavatable with conventional heavy-duty earth moving and trenching equipment.

### **9.6 Pipeline Subgrade Preparation**

The final subgrade surface should be level, firm, uniform, and free of loose materials and properly graded to provide uniform bearing and support to the entire section of the pipe placed on bedding material. Protruding oversize particles, larger than three (3) inches in dimension, if any, should be removed from the trench bottom and replaced with compacted on-site materials.

## **9.7 Pipe Bedding**

Bedding is defined as the material supporting and surrounding the pipe, to 12 inches above the pipe.

The load on the rigid pipes and deflection of flexible pipes and, hence, the pipe design, depends on the type and the amount of bedding placed underneath and around the pipe. Care should be taken to densify the bedding material below the spring line of the pipe.

Bedding material for the pipes should be free from oversized particles (greater than 1-inch). One (1) Sand Equivalent (SE) test was conducted on a representative soil sample with a result of 15. Based on the SE test result, the site soils at the pipe invert depths has an SE value less than 30 and is not suitable to be used as pipe bedding. Pipe design generally requires a granular material with a Sand Equivalent (SE) greater than 30. To provide uniform and firm support for the pipe, compacted granular materials such as clean sand or crushed stone encasement may be used as pipe bedding material. For nominal pipe size, up to and including 15 inches, the crushed rock used as bedding should have a maximum size of  $\frac{1}{2}$  inch, whereas for pipe sizes over 15 inches, the maximum rock size should be  $\frac{3}{4}$  inch.

Migration of fines from the surrounding soils must be considered in selecting the gradation of any imported bedding material. To avoid migration of fines, commercially available geofabric (used for filtration purposes) such as (i.e., Mirafi HP570, 140N, 180N or equivalent) may be used (wrapped around the bedding material encasing the pipe) to separate the bedding material from the surrounding native or fill soils.

## **9.8 Trench Zone Backfill**

The trench zone is defined as the portion of the trench above the pipe bedding extending up to the final grade level of the trench surface.

The following specifications are recommended to provide a basis for quality control during the placement of trench backfill.

Trench excavations to receive backfill shall be free of trash, debris or other unsatisfactory materials at the time of backfill placement. Excavated on-site soils free of oversize particles, defined as larger than one (1) inch in maximum dimension in the upper 12 inches of subgrade soils and larger than three (3) inches in the largest dimension in the trench backfill below, and deleterious matter after proper processing may be used to backfill the trench zone. Imported trench backfill, if used, should be approved by the project soils consultant prior to delivery at the site. No more than 30 percent of the backfill volume should be larger than  $\frac{3}{4}$  inch in the largest dimension.

Trench backfill shall be compacted to 90 percent of the laboratory maximum dry density as per ASTM Standard D1557 test method. At least the upper twelve (12) inches of



trench underlying pavements should be compacted to at least 95 percent of the laboratory maximum dry density.

Trench backfill shall be compacted by mechanical methods, such as sheepsfoot, vibrating or pneumatic rollers, or mechanical tampers, to achieve the density specified herein. The backfill materials shall be brought to within three (3) percent of optimum moisture content and then placed in horizontal layers if the expansion index is less than or equal to 20. Should the expansion index be greater than 20, backfill materials shall be brought to approximately 3 percent above optimum moisture content. The thickness of uncompacted layers should not exceed eight (8) inches. Each layer shall be evenly spread, moistened or dried as necessary, and then tamped or rolled until the specified density has been achieved.

The contractor shall select the equipment and processes to be used to achieve the specified density without damage to adjacent ground and completed work. The field density of the compacted soil shall be measured by the ASTM Standard D1556 or ASTM Standard D6938 test methods or equivalent. Observation and field tests should be performed by Converse during construction to confirm that the required degree of compaction has been obtained. Where compaction is less than that specified, additional compactive effort shall be made with adjustment of the moisture content as necessary, until the specified compaction is obtained. It should be the responsibility of the contractor to maintain safe conditions during cut and/or fill operations. Trench backfill shall not be placed, spread or rolled during unfavorable weather conditions. When the work is interrupted by heavy rain, fill operations shall not be resumed until field tests by the project's geotechnical consultant indicate that the moisture content and density of the fill are as previously specified.

#### 9.8.1 Select Imported Fill Materials for Trench Zone Backfill

Imported soils, if any, used as compacted trench backfill should be predominantly granular and meet the following criteria:

- Expansion Index less than 20
- Free of all deleterious materials
- Contain no particles larger than 3 inches in the largest dimension
- Contain less than 30 percent by weight retained on ¾-inch sieve
- Contain at least 15 percent fines (passing #200 sieve)
- Have a Plasticity Index of 10 or less

Any import fill should be tested and approved by the geotechnical representative prior to delivery to the site.

### **9.9 Expansive Soil Mitigation**

Based on the field investigation, the near-surface earth materials are primarily silty sand, clayey sand, and silt. The site soils were tested for expansion potential per ASTM Standard D4829 and were found to have “very low” expansion potential. The on-site soil materials may be mixed during the grading and the expansion potential might change. Due to this, the expansion potential of site soils should be verified during and after site grading as needed for slabs, foundations and pavement placed directly on expansive subgrade soils will likely crack over time.

To mitigate the expansive soils, on-site clayey soils with an Expansion Index higher than 20 should not be re-used for compaction within 2 feet below the proposed foundations or for retaining wall backfill. The extent of removal should be determined by the project geotechnical engineer or his representative based on soil observations made during grading.

### **9.10 Shrinkage and Subsidence**

Soil shrinkage and/or bulking as a result of remedial grading depends on several factors including the depth of over-excavation, and the grading method and equipment utilized, and average relative compaction. For preliminary estimation, bulking and shrinkage factors for various units of earth material at the site may be taken as presented below:

The approximate shrinkage factor for the native alluvial soils is estimated to range from five (5) to fifteen (15) percent. For estimation purposes, ground subsidence may be taken as 0.15 feet as a result of remedial grading.

Although these values are only approximate, they represent our best estimates of the factors to be used to calculate lost volume that may occur during grading. If more accurate shrinkage and subsidence factors are needed, it is recommended that field-testing using the actual equipment and grading techniques be conducted.

## 10.0 CONSTRUCTION CONSIDERATIONS

### 10.1 General

Site soils should be excavatable using conventional heavy-duty excavating equipment. Temporary sloped excavation is feasible if performed in accordance with the slope ratios provided in Section 10.2, *Temporary Excavations*. Existing utilities should be accurately located and either protected or removed as required.

### 10.2 Temporary Excavations

Based on the sandy clay and silty sand materials encountered near surface in the exploratory borings, sloped temporary excavations (if necessary) may be constructed according to the slope ratios presented in the following table, *Slope Ratios for Temporary Excavations*. Any loose utility trench backfill or other fill encountered in excavations will be less stable than the native soils. Temporary cuts encountering loose fill or loose dry sand may have to be constructed at a flatter gradient than presented in the following table:

**Table No. 12, Slope Ratios for Temporary Excavations**

Maximum Depth of Cut (feet)	Maximum Slope Ratio* (horizontal: vertical)
0 – 4	vertical
4 – 8	1:1
8+	1.5:1

\*Slope ratio assumed to be uniform from top to toe of slope.

Surfaces exposed in slope excavations should be kept moist but not saturated to minimize raveling and sloughing during construction. Adequate provisions should be made to protect the slopes from erosion during periods of rainfall. Surcharge loads, including construction, should not be placed within five (5) feet of the unsupported trench edge. The above maximum slopes are based on a maximum height of six (6) feet of stockpiled soils placed at least five (5) feet from the trench edge.

All applicable requirements of the California Construction and General Industry Safety Orders, the Occupational Safety and Health Act of 1987 and current amendments, and the Construction Safety Act should be met. The soils exposed in cuts should be observed during excavation by the project's geotechnical engineer or engineering geologist. If potentially unstable soil conditions are encountered, modifications of slope ratios for temporary cuts may be required.

### 10.3 Geotechnical Services During Construction

This report has been prepared to aid in the site preparation and site grading plans and specifications, and to assist the architect, civil and structural engineers in the design of

the proposed structure. It is recommended that this office be provided an opportunity to review final design drawings and specifications to verify that the recommendations of this report have been properly implemented.

Recommendations presented herein are based upon the assumption that adequate earthwork monitoring will be provided by Converse. Excavation bottoms should be observed by a Converse representative prior to the placement of compacted fill. Structural fill and backfill should be placed and compacted during continuous observation and testing by this office. Footing excavations should be observed by Converse prior to placement of steel and concrete so that footings are founded on satisfactory materials and excavations are free of loose and disturbed materials.

During construction, the geotechnical engineer and/or their authorized representatives should be present at the site to provide a source of advice to the client regarding the geotechnical aspects of the project and to observe and test the earthwork performed. Their presence should not be construed as an acceptance of responsibility for the performance of the completed work, since it is the sole responsibility of the contractor performing the work to ensure that it complies with all applicable plans, specifications, ordinances, etc.

This firm does not practice or consult in the field of safety engineering. We do not direct the contractor's operations, and cannot be responsible for other than our own personnel on the site; therefore, the safety of others is the responsibility of the contractor. The contractor should notify the owner if he considers any recommended actions presented herein to be unsafe.

## 11.0 CLOSURE

The findings and recommendations of this report were prepared in accordance with generally accepted professional engineering and engineering geologic principles and practice. We make no other warranty, either expressed or implied. Our conclusions and recommendations are based on the results of the field and laboratory investigations, combined with an interpolation and extrapolation of soil conditions between and beyond boring locations. If conditions encountered during construction appear to be different from those shown by the borings, this office should be notified.

Design recommendations given in this report are based on the assumption that the earthwork and site grading recommendations contained in this report are implemented. Additional consultation may be prudent to interpret Converse's findings for contractors, or to possibly refine these recommendations based upon the review of the final site grading and actual site conditions encountered during construction. If the scope of the project changes, if project completion is to be delayed, or if the report is to be used for another purpose, this office should be consulted.

This report was prepared for Mt. San Antonio College for the subject project described herein. We are not responsible for technical interpretations made by others of our exploratory information. Specific questions or interpretations concerning our findings and conclusions may require a written clarification to avoid future misunderstandings.



## 12.0 REFERENCES

- AMERICAN SOCIETY OF CIVIL ENGINEERS, ASCE/SEI 7-10, *Minimum Design Loads for Structures and Other Structures*, copyright 2013.
- ASTM INTERNATIONAL, Annual Book of ASTM Standards, Current.
- BLAKE, T. F., 2000, UBCSEIS, FRISKSP *Computer Program for Performing Deterministic, Probabilistic, and Seismic Coefficient Analysis*.
- BLAKE, T. F., 2002 CGS Fault Model, *Computer Model Files, CGS Source Data, Maps for Performing Probabilistic Seismic Hazard Analysis*, copyright 2004, Thomas F. Blake, August 2004.
- BOORE, D. M., JOYNER, W. B. and FUMAL, T. E., 1997, *Empirical near-source attenuation relationships for horizontal and vertical components of peak ground acceleration, peak ground velocity, and pseudo-absolute acceleration response spectra*, Seismological Research Letters, v. 68, p. 154-179.
- BOZORGNIA, Y., CAMPBELL, K. W., and NIAZI, M., *Vertical ground motion: Characteristics relationship with horizontal component, and building code implications*, Proceedings of the SMIP99 Seminar on Utilization of Strong-Motion Data, 1999, Oakland, California, p. 23 - 49.
- CALIFORNIA BUILDING STANDARDS COMMISSION, 2013, *California Building Code (CBC)*, California Code of Regulations Title 24, Part 2, Volumes 1 and 2.
- CALIFORNIA DEPARTMENT OF CONSERVATION, DIVISION OF MINES AND GEOLOGY, *Seismic Hazard Report for the San Dimas 7.5-Minute Quadrangle, Los Angeles County*.
- CALIFORNIA DIVISION OF MINES AND GEOLOGY, San Dimas Quadrangle, Seismic Hazard Zones (1998)
- CALIFORNIA DIVISION OF MINES AND GEOLOGY, Guidelines for Evaluating and Mitigating Seismic Hazards in California, Special Publication 117, 2008.
- CALIFORNIA GEOLOGIC SURVEY, 2004, Engineering Geology and Seismology for Public Schools and Hospitals in California, by Robert H. Sydnor, Senior Engineering Geologist, July 1, 2004, 227 pages.
- CALIFORNIA GEOLOGIC SURVEY, 2003, 2002 California Fault Parameters-Transverse Ranges and Los Angeles Basin, [www.consrv.ca.gov/cgs/rghm/psha/fault](http://www.consrv.ca.gov/cgs/rghm/psha/fault).

- CALIFORNIA GEOLOGICAL SURVEY-NOTE 48, Checklist for the Review of Engineering Geology and Seismology Reports for California Public Schools, Hospitals, and Essential Services Buildings, October 2013.
- CAO, TIANQING, et. al., 2003, The Revised 2002 California Probabilistic Seismic Hazard Maps, June 2003, pp. 1-11, Appendix A.
- CIVILTECH SOFTWARE, LiquefyPro, Version 5.8n, 2012, A Computer Program for Computation of Liquefaction and Seismic Settlements.
- DOLAN, J. F., et al., 2003, Recognition of Paleo Earthquakes on the Puente Hills Blind Thrust Fault, California, April 4, 2003, *Science*, Vol. 300, pp. 115-118.
- FEDERAL EMERGENCY MANAGEMENT AGENCY (FEMA), U.S. Department of Homeland Security, 2006, Flood Insurance Rate Map (FIRM) Panel 1725 of 2350, Map No. 06037C1725F, dated September 26, 2006. Online <http://msc.fema.gov>.
- JENNINGS, CHARLES W. 1994. "Fault Activity Map of California and Adjacent Areas with Location and Ages of Recent Volcanic Eruptions." *California Geologic Data Map Series*, Map No. 6. California Division of Mines and Geology.
- NATIONAL CENTER FOR EARTHQUAKE ENGINEERING RESEARCH (NCEER), Proceedings of the NCEER Workshop on Evaluation of Liquefaction Resistance of Soils, Edited by T. L. Youd and I. M. Idriss, Technical Report NCEER-97-0022, 1997.
- RUBIN, C. M., et. al, 1998, Evidence for Large Earthquakes in Metropolitan Los Angeles, *AAAS Science*, Vol. 281, p. 398-402.
- RUBIN, C. M., et. al., 1998, Evidence for Large Earthquakes in Metropolitan Los Angeles, July 17, 1998, *Science*, Vol. 281, pp. 398-402.
- SOUTHERN CALIFORNIA EARTHQUAKE CENTER, SOUTHERN CALIFORNIA CATALOGS, 1932-Present Earthquake Catalog. Online March 14, 2011. [http://www.data.scec.org/catalog\\_search/radius.php](http://www.data.scec.org/catalog_search/radius.php)
- STANDARD SPECIFICATIONS FOR PUBLIC WORKS CONSTRUCTION, 2012, Public Works Standards, Inc.
- STUDIES IN GEOPHYSICS, 1986, Active Tectonics, Geophysics Study Committee, National Academy Press.
- TOPPOZADA, T., et. al., 2000, Epicenters of and Areas Damaged by  $M \geq 5$  California Earthquakes, 1800-1999, Map Sheet 49, California Geologic Survey.

YEATS, ROBERT S., 2004, Tectonics of the San Gabriel Basin and Surroundings, Southern California, GSA Bulletin, September / October 2004, v. 116, no. 9/10, p. 1158-1182.

ZIONY, J. I., EDITOR, 1985, Evaluating Earthquake Hazards in the Los Angeles Region – An Earth-Science Perspective, USGS Professional Paper 1360.

# Appendix A

Field Exploration

## APPENDIX A: FIELD EXPLORATION

Field exploration included an initial site reconnaissance, and subsurface drilling. During the site reconnaissance, surface conditions were noted and the locations of the test borings were determined. Borings were approximately located using existing features and GPS as a guide.

Prior to field exploration, Underground Service Alert (USA) was notified 48 hours in advance. The proposed boring sites were evaluated by Ground Penetrating Radar Systems, Inc. to check for buried utility lines. Any borings located within or near the utility markings was relocated to a different location within the local proximity. High concentrations of buried utility lines were located beneath planter areas and sidewalks on the east and west sides of the project site.

Eight (8) exploratory borings (BH-1 through BH-8) were advanced within the project site on August 14, 2017, August 15, 2017, and August 24, 2017. The borings were advanced using a truck mounted drill rig with an 8-inch diameter hollow stem auger to a maximum depth of 51.5 feet below the existing ground surface (bgs) or by hand auger methods (BH-4 and BH-6) in limited access areas. Each boring was visually logged by a Converse engineer and sampled at regular intervals and at changes in subsurface soils, in accordance with the Unified Soil Classification System. Per the college's instruction, the top five feet of soil were advanced using a hand-auger to check for buried utility lines. Field descriptions have been modified, where appropriate, to reflect laboratory test results.

Relatively undisturbed ring and bulk samples of the subsurface soils were obtained at frequent intervals in the borings. The undisturbed samples were obtained using a California Steel Sampler (2.4 inches inside diameter and 3.0 inches outside diameter) lined with thin sample rings. The sampler was driven into the bottom of the boreholes with successive drops of a 140-pound hammer falling 30 inches by means of a mechanically driven automatic trip hammer. The number of successive drops of the driving weight ("blows") required for every 6-inch of penetration of the sampler are shown on the Logs of Borings in the "blows" column.

The soil was retained in brass rings (2.4 inches in diameter and one inch in height). The central portion of the sample was retained and carefully sealed in waterproof plastic containers for shipment to the laboratory. Bulk soil samples were also collected in plastic bags and brought to the laboratory.

Standard Penetration Tests (SPTs) were also performed. In this test, a standard split-spoon sampler (1.4 inches inside diameter and 2.0 inches outside diameter) was driven into the ground with successive drops of a 140-pound hammer falling 30 inches by means of an automatic hammer. The number of successive drops of the driving weight ("blows") required for every 6-inch of penetration of the sampler are shown on the Logs of Borings



in the "blows" column. The soil retrieved from the spoon sampler was carefully sealed in waterproof plastic containers for shipment to the laboratory.

It should be noted that the exact depths at which material changes occur cannot always be established accurately. Changes in material conditions that occur between driven samples are indicated in the logs at the top of the next drive sample. A key to soil symbols and terms is presented as Drawing No. A-1, *Soil Classification Chart*. The logs of the exploratory boring are presented in Drawing Nos. A-2a through A-9, *Log of Borings*.

# SOIL CLASSIFICATION CHART

MAJOR DIVISIONS			SYMBOLS		TYPICAL DESCRIPTIONS
			GRAPH	LETTER	
<b>COARSE GRAINED SOILS</b>  <small>MORE THAN 50% OF MATERIAL IS LARGER THAN NO. 200 SIEVE SIZE</small>	<b>GRAVEL AND GRAVELLY SOILS</b>  <small>MORE THAN 50% OF COARSE FRACTION RETAINED ON NO. 4 SIEVE</small>	<b>CLEAN GRAVELS</b>  <small>(LITTLE OR NO FINES)</small>		<b>GW</b>	WELL-GRADED GRAVELS, GRAVEL - SAND MIXTURES, LITTLE OR NO FINES
				<b>GP</b>	POORLY-GRADED GRAVELS, GRAVEL - SAND MIXTURES, LITTLE OR NO FINES
		<b>GRAVELS WITH FINES</b>  <small>(APPRECIABLE AMOUNT OF FINES)</small>		<b>GM</b>	SILTY GRAVELS, GRAVEL - SAND - SILT MIXTURES
				<b>GC</b>	CLAYEY GRAVELS, GRAVEL - SAND - CLAY MIXTURES
	<b>SAND AND SANDY SOILS</b>  <small>MORE THAN 50% OF COARSE FRACTION PASSING ON NO. 4 SIEVE</small>	<b>CLEAN SANDS</b>  <small>(LITTLE OR NO FINES)</small>		<b>SW</b>	WELL-GRADED SANDS, GRAVELLY SANDS, LITTLE OR NO FINES
				<b>SP</b>	POORLY-GRADED SANDS, GRAVELLY SAND, LITTLE OR NO FINES
		<b>SANDS WITH FINES</b>  <small>(APPRECIABLE AMOUNT OF FINES)</small>		<b>SM</b>	SILTY SANDS, SAND - SILT MIXTURES
				<b>SC</b>	CLAYEY SANDS, SAND - CLAY MIXTURES
<b>FINE GRAINED SOILS</b>  <small>MORE THAN 50% OF MATERIAL IS SMALLER THAN NO. 200 SIEVE SIZE</small>	<b>SILTS AND CLAYS</b>  <small>LIQUID LIMIT LESS THAN 50</small>			<b>ML</b>	INORGANIC SILTS AND VERY FINE SANDS, ROCK FLOUR, SILTY OR CLAYEY FINE SANDS OR CLAYEY SILTS WITH SLIGHT PLASTICITY
				<b>CL</b>	INORGANIC CLAYS OF LOW TO MEDIUM PLASTICITY, GRAVELLY CLAYS, SANDY CLAYS, SILTY CLAYS, LEAN CLAYS
				<b>OL</b>	ORGANIC SILTS AND ORGANIC SILTY CLAYS OF LOW PLASTICITY
	<b>SILTS AND CLAYS</b>  <small>LIQUID LIMIT GREATER THAN 50</small>			<b>MH</b>	INORGANIC SILTS, MICACEOUS OR DIATOMACEOUS FINE SAND OR SILTY SOILS
				<b>CH</b>	INORGANIC CLAYS OF HIGH PLASTICITY
				<b>OH</b>	ORGANIC CLAYS OF MEDIUM TO HIGH PLASTICITY, ORGANIC SILTS
<b>HIGHLY ORGANIC SOILS</b>				<b>PT</b>	PEAT, HUMUS, SWAMP SOILS WITH HIGH ORGANIC CONTENTS

NOTE: DUAL SYMBOLS ARE USED TO INDICATE BORDERLINE SOIL CLASSIFICATIONS

### SAMPLE TYPE

	<b>STANDARD PENETRATION TEST</b> Split barrel sampler in accordance with ASTM D-1586-84 Standard Test Method
	<b>DRIVE SAMPLE</b> 2.42" I.D. sampler.
	<b>DRIVE SAMPLE</b> No recovery
	<b>BULK SAMPLE</b>
	<b>GRAB SAMPLE</b>
	<b>GROUNDWATER WHILE DRILLING</b>
	<b>GROUNDWATER AFTER DRILLING</b>

### BORING LOG SYMBOLS

LABORATORY TESTING ABBREVIATIONS		
<b>TEST TYPE</b> <small>(Results shown in Appendix B)</small>	<b>STRENGTH</b>	
	Pocket Penetrometer	p
	Direct Shear	ds
	Direct Shear (single point)	ds*
	Unconfined Compression	uc
	Triaxial Compression	tx
	Vane Shear	vs
<b>CLASSIFICATION</b>		
Plasticity	pi	
Grain Size Analysis	ma	
Passing No. 200 Sieve	wa	
Sand Equivalent	se	
Expansion Index	ei	
Compaction Curve	max	
Hydrometer	h	
	Consolidation	c
	Collapse Test	col
	Resistance (R) Value	r
	Chemical Analysis	ca
	Electrical Resistivity	er

## UNIFIED SOIL CLASSIFICATION AND KEY TO BORING LOG SYMBOLS



**Converse Consultants**

Project Name  
**STUDENT CENTER BUILDING  
 MT. SAN ANTONIO COLLEGE  
 WALNUT, CALIFORNIA**

Project No.  
**17-31-234-01**

Figure No.  
**A-1**

# Log of Boring No. BH-1

Dates Drilled: 8/14/2017      Logged by: VN      Checked By: MBS

Equipment: 8" HOLLOW STEM AUGER      Driving Weight and Drop: 140 lbs / 30 in

Ground Surface Elevation (ft): 769      Depth to Water (ft): NOT ENCOUNTERED

Depth (ft)	Graphic Log	SUMMARY OF SUBSURFACE CONDITIONS <small>This log is part of the report prepared by Converse for this project and should be read together with the report. This summary applies only at the location of the boring and at the time of drilling. Subsurface conditions may differ at other locations and may change at this location with the passage of time. The data presented is a simplification of actual conditions encountered.</small>	SAMPLES		BLOWS/6"	MOISTURE (%)	DRY UNIT WT. (pcf)	OTHER
			DRIVE	BULK				
		<b>FILL (Af):</b> <b>SILTY SAND (SM):</b> fine to coarse-grained, few gravel, brown, grass and roots top 6-inches.						ca,er ma (fc=21.2%)
5		<b>ALLUVIUM (Qal):</b> <b>CLAYEY SAND (SC):</b> fine to coarse-grained, reddish brown.  -fine to coarse-grained, trace gravel up to 1" in maximum dimension, reddish brown			2/4/6	13	118	c
10		-fine to coarse-grained, trace organics (roots), reddish brown			4/5/6	11	116	
15		-fine to coarse-grained, trace gravel up to 3/4" in maximum dimension, reddish brown			3/4/5	11	117	wa (fc=29%)
20					8/13/23	13	122	
25		<b>SILTY SAND (SM):</b> trace clay, reddish brown.			10/16/20			wa (fc=37%)
30		-fine to coarse-grained, trace clay, reddish brown			19/16/22	14	117	



**Converse Consultants**

Project Name  
STUDENT CENTER BUILDING  
MT. SAN ANTONIO COLLEGE  
WALNUT, CALIFORNIA

Project No.  
17-31-234-01

Figure No.  
A-2a

# Log of Boring No. BH-1

Dates Drilled: 8/14/2017      Logged by: VN      Checked By: MBS

Equipment: 8" HOLLOW STEM AUGER      Driving Weight and Drop: 140 lbs / 30 in

Ground Surface Elevation (ft): 769      Depth to Water (ft): NOT ENCOUNTERED

Depth (ft)	Graphic Log	SUMMARY OF SUBSURFACE CONDITIONS <small>This log is part of the report prepared by Converse for this project and should be read together with the report. This summary applies only at the location of the boring and at the time of drilling. Subsurface conditions may differ at other locations and may change at this location with the passage of time. The data presented is a simplification of actual conditions encountered.</small>	SAMPLES		BLOWS/6"	MOISTURE (%)	DRY UNIT WT. (pcf)	OTHER
			DRIVE	BULK				
40	[Hatched Pattern]	<b>SANDY CLAY (CL):</b> fine to medium-grained, trace silt, reddish brown.	X		11/21/27			wa (fc=51%)
45	[Hatched Pattern]	<b>CLAYEY SAND (SC):</b> fine to medium-grained, trace silt, reddish brown.	X		8/5/6			wa (fc=45%)
50	[Hatched Pattern]		X		9/11/15			
		End of boring at 51.5 feet Groundwater not encountered during drilling. Borehole backfilled with soil cuttings and tamped on 8-14-17.						



**Converse Consultants**

Project Name  
STUDENT CENTER BUILDING  
MT. SAN ANTONIO COLLEGE  
WALNUT, CALIFORNIA

Project No.  
17-31-234-01

Figure No.  
A-2b

# Log of Boring No. BH-2

Dates Drilled: 8/14/2017      Logged by: VN      Checked By: MBS

Equipment: 8" HOLLOW STEM AUGER      Driving Weight and Drop: 140 lbs / 30 in

Ground Surface Elevation (ft): 767      Depth to Water (ft): NOT ENCOUNTERED

Depth (ft)	Graphic Log	SUMMARY OF SUBSURFACE CONDITIONS <small>This log is part of the report prepared by Converse for this project and should be read together with the report. This summary applies only at the location of the boring and at the time of drilling. Subsurface conditions may differ at other locations and may change at this location with the passage of time. The data presented is a simplification of actual conditions encountered.</small>	SAMPLES		BLOWS/6"	MOISTURE (%)	DRY UNIT WT. (pcf)	OTHER
			DRIVE	BULK				
5		<b>FILL (Af):</b> <b>CLAYEY SAND (SC):</b> fine to coarse-grained, brown, grass and roots top 6-inches.						
		<b>ALLUVIUM (Qal):</b> <b>CLAYEY SAND (SC):</b> fine to coarse-grained, reddish brown.			6/9/11	11	122	
10		-trace gravel 1/2" in maximum dimension,			4/5/5	12	133	
15		<b>SANDY CLAY (CL):</b> fine to coarse-grained, brown.			3/3/3			
20		-light brown			10/21/26	11	122	
25		-fine to coarse-grained, reddish brown			11/8/11			
		End of boring at 26.5 feet. Groundwater not encountered during drilling. Borehole backfilled with soil cuttings and tamped on 8-14-17						



**Converse Consultants**

Project Name  
STUDENT CENTER BUILDING  
MT. SAN ANTONIO COLLEGE  
WALNUT, CALIFORNIA

Project No.  
17-31-234-01

Figure No.  
A-3



# Log of Boring No. BH-3

Dates Drilled: 8/14/2017      Logged by: VN      Checked By: MBS

Equipment: 8" HOLLOW STEM AUGER      Driving Weight and Drop: 140 lbs / 30 in

Ground Surface Elevation (ft): 766      Depth to Water (ft): NOT ENCOUNTERED

Depth (ft)	Graphic Log	SUMMARY OF SUBSURFACE CONDITIONS <small>This log is part of the report prepared by Converse for this project and should be read together with the report. This summary applies only at the location of the boring and at the time of drilling. Subsurface conditions may differ at other locations and may change at this location with the passage of time. The data presented is a simplification of actual conditions encountered.</small>	SAMPLES		BLOWS/6"	MOISTURE (%)	DRY UNIT WT. (pcf)	OTHER
			DRIVE	BULK				
		<b>FILL (Af):</b> <b>CLAYEY SAND (SC):</b> fine to medium-grained, trace silt, brown, grass and roots top 6-inches.						max
5		<b>ALLUVIUM (Qal):</b> <b>SANDY CLAY (CL):</b> fine to coarse-grained, trace silt, brown.			10/12/10	8	122	ds
10					4/6/7	11	115	
15					2/3/8			
20		<b>CLAYEY SAND (SC):</b> fine to coarse-grained, trace silt, trace gravel, brown with white mottling.			9/20/30	13	112	
25					6/16/22			
		End of boring at 26.5 feet. Groundwater not encountered during drilling. Borehole backfilled with soil cuttings and tamped on 8-14-17.						



**Converse Consultants**

Project Name  
 STUDENT CENTER BUILDING  
 MT. SAN ANTONIO COLLEGE  
 WALNUT, CALIFORNIA

Project No.  
 17-31-234-01

Figure No.  
 A-4

# Log of Boring No. BH-4

Dates Drilled: 8/24/2017      Logged by: RAM      Checked By: MBS

Equipment: Hand Auger      Driving Weight and Drop: N/A

Ground Surface Elevation (ft): 762.5      Depth to Water (ft): NOT ENCOUNTERED

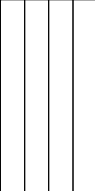
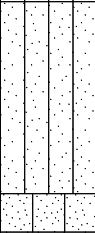
Depth (ft)	Graphic Log	<b>SUMMARY OF SUBSURFACE CONDITIONS</b> This log is part of the report prepared by Converse for this project and should be read together with the report. This summary applies only at the location of the boring and at the time of drilling. Subsurface conditions may differ at other locations and may change at this location with the passage of time. The data presented is a simplification of actual conditions encountered.	SAMPLES		BLOWS/6"	MOISTURE (%)	DRY UNIT WT. (pcf)	OTHER
			DRIVE	BULK				
5		<b>FILL (Af):</b> <b>SILT (ML):</b> dark brown, grass and roots top 6-inches.	■					
10		<b>ALLUVIUM (Qal):</b> <b>SANDY SILT (ML):</b> fine to coarse-grained, brown.	■			12	108	
		<b>SILTY SAND (SM):</b> with gravel, brown.	■			10	110	
		End of hand auger boring at 11 feet. Groundwater not encountered during drilling. Performed field percolation test. Borehole backfilled with soil cuttings and tamped on 8-24-17.						



**Converse Consultants**

Project Name  
 STUDENT CENTER BUILDING  
 MT. SAN ANTONIO COLLEGE  
 WALNUT, CALIFORNIA

Project No.  
 17-31-234-01

Figure No.  
 A-5

# Log of Boring No. BH-5

Dates Drilled: 8/14/2017      Logged by: VN      Checked By: MBS

Equipment: 8" HOLLOW STEM AUGER      Driving Weight and Drop: 140 lbs / 30 in

Ground Surface Elevation (ft): 764.5      Depth to Water (ft): 47.5

Depth (ft)	Graphic Log	SUMMARY OF SUBSURFACE CONDITIONS <small>This log is part of the report prepared by Converse for this project and should be read together with the report. This summary applies only at the location of the boring and at the time of drilling. Subsurface conditions may differ at other locations and may change at this location with the passage of time. The data presented is a simplification of actual conditions encountered.</small>	SAMPLES		BLOWS/6"	MOISTURE (%)	DRY UNIT WT. (pcf)	OTHER
			DRIVE	BULK				
5		<b>FILL (Af):</b> <b>CLAYEY SAND (SC):</b> fine-grained, some silt, brown, grass and roots top 6-inches.						ei
		<b>ALLUVIUM (Qal):</b> <b>CLAYEY SAND (SC):</b> fine-grained, trace silt, reddish brown.			8/15/20	12	126	
10		-fine to coarse-grained, gravel up to 1/2" in maximum dimension, reddish brown			4/4/5	9	127	c
15		-fine to coarse-grained, reddish brown			11/21/31	16	118	
20					5/6/10			
25		fine to coarse-grained, reddish brown			11/16/19	11	123	
30		CLAYEY SAND (SC): fine to coarse-grained, trace silt, reddish brown.			5/14/16	15	116	



**Converse Consultants**

Project Name  
 STUDENT CENTER BUILDING  
 MT. SAN ANTONIO COLLEGE  
 WALNUT, CALIFORNIA

Project No.  
 17-31-234-01

Figure No.  
 A-6a

# Log of Boring No. BH-5

Dates Drilled: 8/14/2017      Logged by: VN      Checked By: MBS

Equipment: 8" HOLLOW STEM AUGER      Driving Weight and Drop: 140 lbs / 30 in

Ground Surface Elevation (ft): 764.5      Depth to Water (ft): 47.5

Depth (ft)	Graphic Log	SUMMARY OF SUBSURFACE CONDITIONS <small>This log is part of the report prepared by Converse for this project and should be read together with the report. This summary applies only at the location of the boring and at the time of drilling. Subsurface conditions may differ at other locations and may change at this location with the passage of time. The data presented is a simplification of actual conditions encountered.</small>	SAMPLES		BLOWS/6"	MOISTURE (%)	DRY UNIT WT. (pcf)	OTHER
			DRIVE	BULK				
40		<b>CLAYEY SAND (SC):</b> fine to coarse-grained, reddish brown.	■	■	22/25/22	15	116	
45		<b>SANDY CLAY (CL):</b> fine to coarse-grained, reddish brown.	■	■	9/15/21			
50			End of boring at 51.5 feet. Groundwater encountered at 47.5 feet. Borehole backfilled with soil cuttings and tamped on 8-14-17.	■	■	10/14/15	15	115
			■	■	15/10/10			



**Converse Consultants**







Project Name  
 STUDENT CENTER BUILDING  
 MT. SAN ANTONIO COLLEGE  
 WALNUT, CALIFORNIA

Project No.  
 17-31-234-01

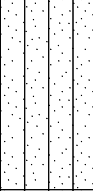
Figure No.  
 A-6b

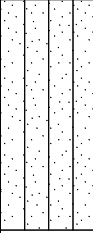
# Log of Boring No. BH-6

Dates Drilled: 8/24/2017      Logged by: RAM      Checked By: MBS  
 Equipment: Hand Auger      Driving Weight and Drop: N/A  
 Ground Surface Elevation (ft): 763      Depth to Water (ft): NOT ENCOUNTERED

Depth (ft)	Graphic Log	SUMMARY OF SUBSURFACE CONDITIONS <small>This log is part of the report prepared by Converse for this project and should be read together with the report. This summary applies only at the location of the boring and at the time of drilling. Subsurface conditions may differ at other locations and may change at this location with the passage of time. The data presented is a simplification of actual conditions encountered.</small>	SAMPLES		BLOWS/6"	MOISTURE (%)	DRY UNIT WT. (pcf)	OTHER
			DRIVE	BULK				
5		<p><b>FILL (Af):</b>  <b>SANDY SILT (ML):</b> fine to coarse-grained, brown, grass to roots top 6-inches.</p>						
10		<p><b>ALLUVIUM (Qal):</b>  <b>SANDY SILT (ML):</b> fine to coarse-grained, light brown.</p>				12	115	
		<p>End of hand auger boring at 11 feet.            Groundwater not encountered during drilling.            Borehole backfilled with soil cuttings, tamped and patched on 8-24-17.</p>				14	117	



**Converse Consultants**

Project Name  
 STUDENT CENTER BUILDING  
 MT. SAN ANTONIO COLLEGE  
 WALNUT, CALIFORNIA

Project No.  
 17-31-234-01

Figure No.  
 A-7

# Log of Boring No. BH-7

Dates Drilled: 8/15/2017      Logged by: RAM      Checked By: MBS

Equipment: 8" HOLLOW STEM AUGER      Driving Weight and Drop: 140 lbs / 30 in

Ground Surface Elevation (ft): 754.5      Depth to Water (ft): NOT ENCOUNTERED

Depth (ft)	Graphic Log	<p style="text-align: center;"><b>SUMMARY OF SUBSURFACE CONDITIONS</b></p> <p style="font-size: small;">This log is part of the report prepared by Converse for this project and should be read together with the report. This summary applies only at the location of the boring and at the time of drilling. Subsurface conditions may differ at other locations and may change at this location with the passage of time. The data presented is a simplification of actual conditions encountered.</p>	SAMPLES		BLOWS/6"	MOISTURE (%)	DRY UNIT WT. (pcf)	OTHER
			DRIVE	BULK				
		<p><b>FILL (Af):</b>  <b>SILT (ML):</b> light brown, grass and roots top 6-inches.</p>						r,ca,er
5		<p><b>ALLUVIUM (Qal):</b>  <b>SILT (ML):</b> light brown.</p>			7/10/14	8	117	
10		<p><b>CLAYEY SAND (SC):</b> fine to coarse-grained, with gravel, brown.</p>			11/18/18	12	115	ds
15		-with gravel, reddish brown			10/19/24	12	117	
20		<p><b>SAND (SP):</b> fine to coarse-grained, with gravel, weathered rock, white.</p>			26/16/30			
25		<p><b>SANDY SILT (ML):</b> with gravel, weathered rock particles, reddish brown.</p>			11/30(4")	10	121	
		<p>End of boring at 26.5 feet.                      Groundwater not encountered during drilling.                      Borehole backfilled with soil cuttings and tamped on 8-15-17.</p>						



**Converse Consultants**

Project Name  
 STUDENT CENTER BUILDING  
 MT. SAN ANTONIO COLLEGE  
 WALNUT, CALIFORNIA

Project No.  
 17-31-234-01

Figure No.  
 A-8











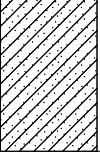

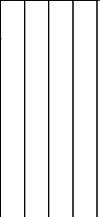
# Log of Boring No. BH-8

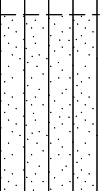
Dates Drilled: 8/15/2017      Logged by: RAM      Checked By: MBS

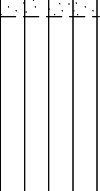
Equipment: 8" HOLLOW STEM AUGER      Driving Weight and Drop: 140 lbs / 30 in

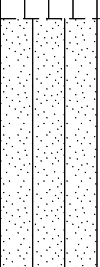
Ground Surface Elevation (ft): 752      Depth to Water (ft): NOT ENCOUNTERED

Depth (ft)	Graphic Log	SUMMARY OF SUBSURFACE CONDITIONS <small>This log is part of the report prepared by Converse for this project and should be read together with the report. This summary applies only at the location of the boring and at the time of drilling. Subsurface conditions may differ at other locations and may change at this location with the passage of time. The data presented is a simplification of actual conditions encountered.</small>	SAMPLES		BLOWS/6"	MOISTURE (%)	DRY UNIT WT. (pcf)	OTHER
			DRIVE	BULK				
		<b>FILL (Af):</b> <b>SILTY CLAYEY SAND (SC-SM):</b> few gravel, brown, grass and roots top 6-inches.						ma,se (fc=38.9%)
5		<b>ALLUVIUM (Qal):</b> <b>SILT (ML):</b> brown.			17/21/17	14	120	
10		<b>SANDY SILT (ML):</b> fine coarse-grained, with gravels, brown.			5/7/9	13	118	
15		<b>SILT (ML):</b> with gravels.			13/25/30	14	120	
20		<b>SILTY SAND (SM):</b> fine to coarse-grained, light brown.			10/12/22			
25					20/30/35	10	124	
		End of boring at 26.5 feet. Groundwater not encountered during drilling. Borehole backfilled with soil cuttings and tamped on 8-15-17.						



**Converse Consultants**

Project Name  
STUDENT CENTER BUILDING  
MT. SAN ANTONIO COLLEGE  
WALNUT, CALIFORNIA

Project No.  
17-31-234-01

Figure No.  
A-9

# Appendix B

Laboratory Testing Program

## **APPENDIX B: LABORATORY TESTING PROGRAM**

Tests were conducted in our laboratory on representative soil samples for the purpose of classification and evaluation of their relevant physical characteristics and engineering properties. The amount and selection of tests were based on the geotechnical requirements of the project. Test results are presented herein and on the Logs of Borings in Appendix A, *Field Exploration*. The following is a summary of the laboratory tests conducted for this project.

### ***B1.1 Moisture Content and Dry Density***

Results of moisture content and dry density tests, performed on relatively undisturbed ring samples were used to aid in the classification of the soils and to provide quantitative measure of the *in situ* dry density. Data obtained from this test provides qualitative information on strength and compressibility characteristics of site soils. For test results, see the Logs of Borings in Appendix A, *Field Exploration*.

### ***B1.2 Grain-Size Analysis***

To assist in classification of soils, mechanical grain-size analysis was performed on two (2) selected samples. Testing was performed in general accordance with the ASTM Standard C136 test method. Grain-size curves are shown in Drawing No. B-1, *Grain Size Distribution Results*.

### ***B1.3 Maximum Dry Density Test***

A laboratory maximum dry density-moisture content relationship test was performed on one (1) representative bulk sample. The test was conducted in accordance with ASTM Standard D1557 laboratory procedure. The test result is presented in Drawing No. B-2, *Moisture-Density Relationship Result*.

### ***B1.4 Direct Shear***

Direct shear tests were performed on two (2) relatively undisturbed soil sample. The test was performed at soaked moisture conditions. For this test the sample, contained in brass sampler rings, was placed directly into the test apparatus and subjected to a range of normal loads appropriate for the anticipated conditions. The sample was then sheared at a constant strain rate of 0.004 inch/minute. Shear deformation was recorded until a maximum of about 0.25-inch shear displacement was achieved. Ultimate strength was selected from the shear-stress deformation data and plotted to determine the shear strength parameters. For test data, including sample density and moisture content, see Drawing Nos. B-3 and B-4, *Direct Shear Test Results*, and in the following table:

**Table No. B-1, Direct Shear Test Results**

Boring No.	Depth (feet)	Soil Classification	Ultimate Strength Parameters	
			Friction Angle (degrees)	Cohesion (psf)
BH-3	5.0	Clayey Sand (SC)	30	240
BH-7	10.0	Clayey Sand (SC)	32	530

**B1.5 Consolidation Test**

A Consolidation test was performed on two (2) relatively undisturbed samples. Data obtained from this test was used to evaluate the settlement characteristics of the foundation soils under load. Preparation for this test involved trimming the sample and placing the one-inch high brass ring into the test apparatus, which contained porous stones, both top and bottom, to accommodate drainage during testing. Normal axial loads were applied to one end of the sample through the porous stones, and the resulting deflections were recorded at various time periods. The load was increased after the sample reached a reasonable state equilibrium. Normal loads were applied at a constant load-increment ratio, successive loads being generally twice the preceding load. The sample was tested at field and submerged conditions. The test results, including sample density and moisture content, are presented in Drawing Nos. B-5 and B-6, *Consolidation Test Results*.

**B1.6 Soil Corrosivity**

Converse retained the Environmental Geotechnology Laboratory, Inc., located in Arcadia, California, to test two (2) bulk soil samples taken in the general area of the proposed structure. The tests included minimum resistivity, pH, soluble sulfates, and chloride content, with the results summarized in the following table:

**Table No. B-2, Soil Corrosivity Test Results**

Boring No.	Sample Depth (feet)	pH (Caltrans 643)	Soluble Chlorides (Caltrans 422) ppm	Soluble Sulfate (Caltrans 417) % by Weight	Saturated Resistivity (Caltrans 532) Ohm-cm
BH-1	0-5.0	6.78	145	0.014	2,700
BH-9	0-5.0	7.16	240	0.019	2,200

**B1.7 Expansion Index**

One (1) representative bulk sample was tested to evaluate the expansion potential of material encountered at the site. The test was conducted in accordance with ASTM D4829 Standard. Test results are presented in the following table:

**Table No. B-3, Expansion Index Test Result**

Boring No.	Depth (feet)	Soil Description	Expansion Index	Expansion Potential
BH-5	0-5.0	Sandy Silt (ML), trace clay	2.3	Very Low

**B1.8 Sand Equivalent**

One (1) representative soil sample were tested in accordance with the ASTM D2419 test method. The test result is presented in the following table.

**Table No. B-4, Sand Equivalent Test Result**

Boring No.	Depth (feet)	Soil Description	Sand Equivalent
BH-5	0-5.0	Silty Clayey Sand (SC-SM)	25

**B1.9 R-value**

One (1) representative bulk soil sample was tested for resistance value (R-value) in accordance with State of California Standard Method 301. This test is designed to provide a relative measure of soil strength for use in pavement design. The test result is shown in the following table, *R-value Test Results*:

**Table No. B-5, R-value Test Results**

Boring No.	Depth (ft)	Soil Classification	Measured R-value
BH-7	0-5.0'	Silt (ML)	17

**B1.10 Sample Storage**

Soil samples presently stored in our laboratory will be discarded 30 days after the date of this report, unless this office receives a specific request to retain the samples for a longer period.

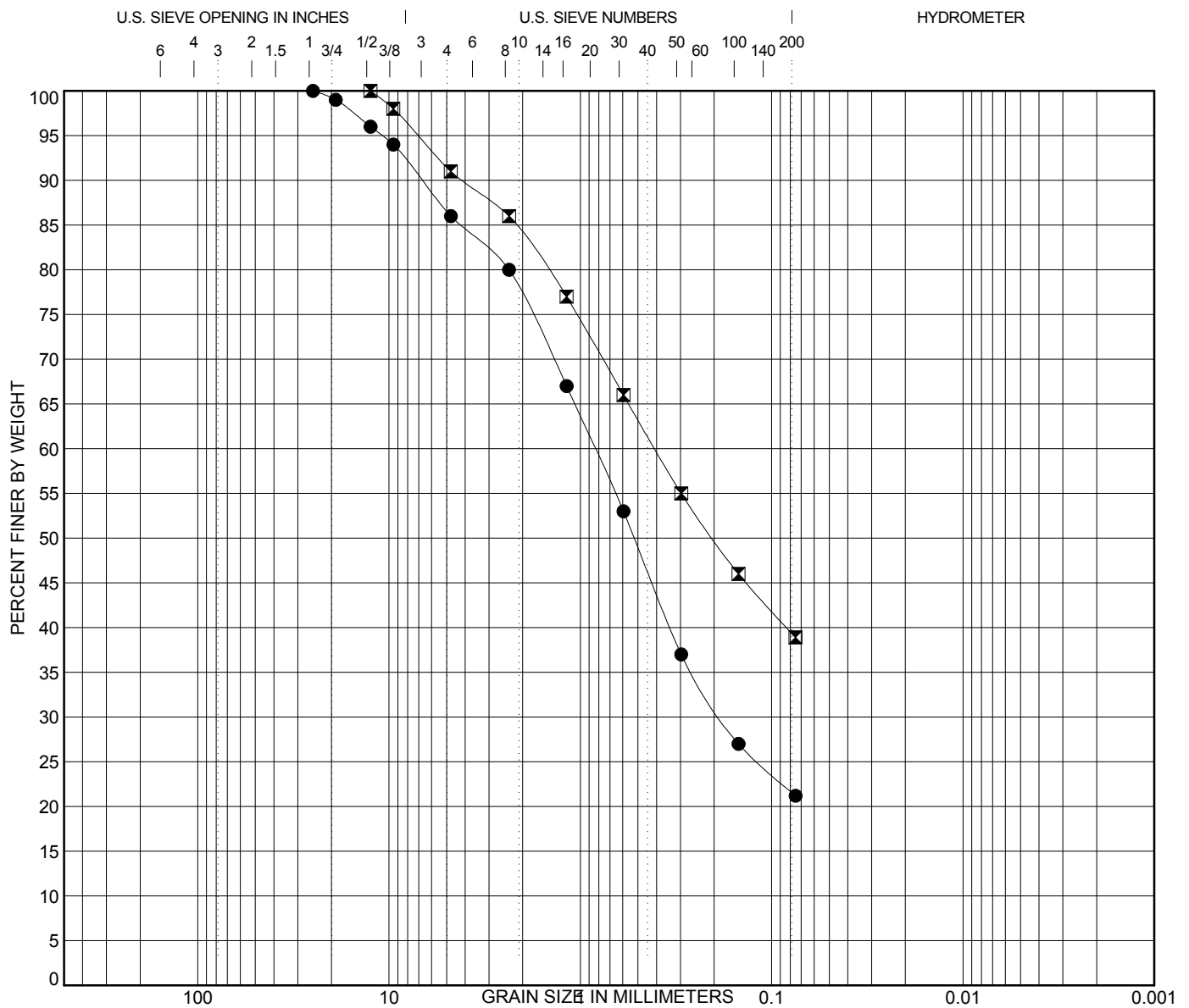

COBBLES	GRAVEL		SAND			SILT OR CLAY
	coarse	fine	coarse	medium	fine	

Boring No.	Depth (ft)	Description					LL	PL	PI	Cc	Cu
● BH-1	0-5	SILTY SAND (SM)									
☒ BH-8	0-5	SILTY CLAYEY SAND (SC-SM)									
Boring No.	Depth (ft)	D100	D60	D30	D10	%Gravel	%Sand	%Silt	%Clay		
● BH-1	0-5	25	0.838	0.183		14.0	64.8	21.2			
☒ BH-8	0-5	12.5	0.407			9.0	52.1	38.9			

### GRAIN SIZE DISTRIBUTION RESULTS



**Converse Consultants**

Project Name  
STUDENT CENTER BUILDING  
MT. SAN ANTONIO COLLEGE  
WALNUT, CALIFORNIA

Project No.  
17-31-234-01

Figure No.  
B-1



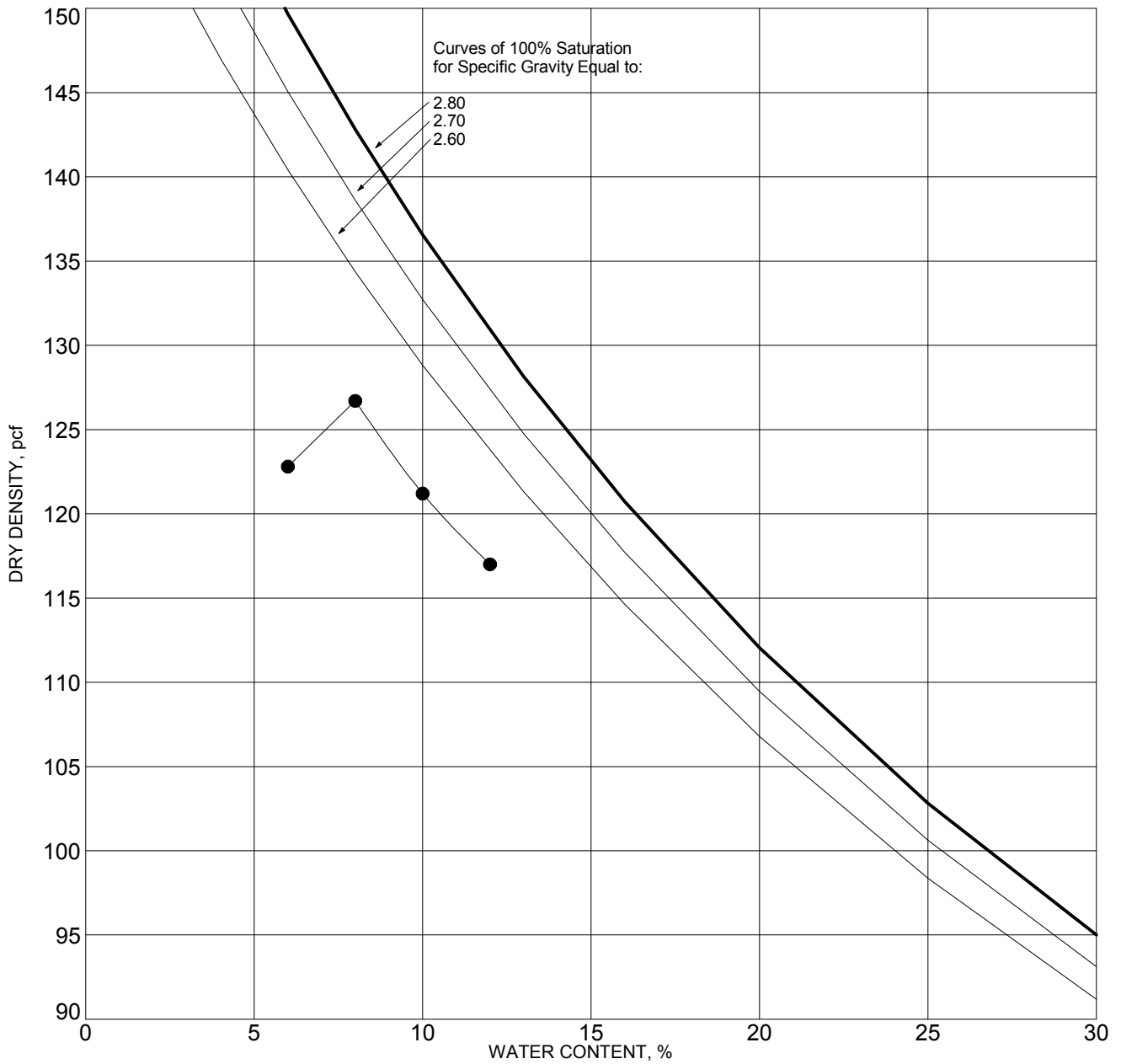

SYMBOL	BORING NO.	DEPTH (ft)	DESCRIPTION	ASTM TEST METHOD	OPTIMUM WATER, %	MAXIMUM DRY DENSITY, pcf
●	BH-3	0-5.0	CLAYEY SAND (SC)	D1557 Method B	9	127

NOTE:

## MOISTURE-DENSITY RELATIONSHIP RESULTS



**Converse Consultants**

Project Name  
 MT. SAN ANTONIO COLLEGE  
 STUDENT CENTER BUILDING  
 WALNUT, CALIFORNIA

Project No.  
 17-31-234-01

Figure No.  
 B-2

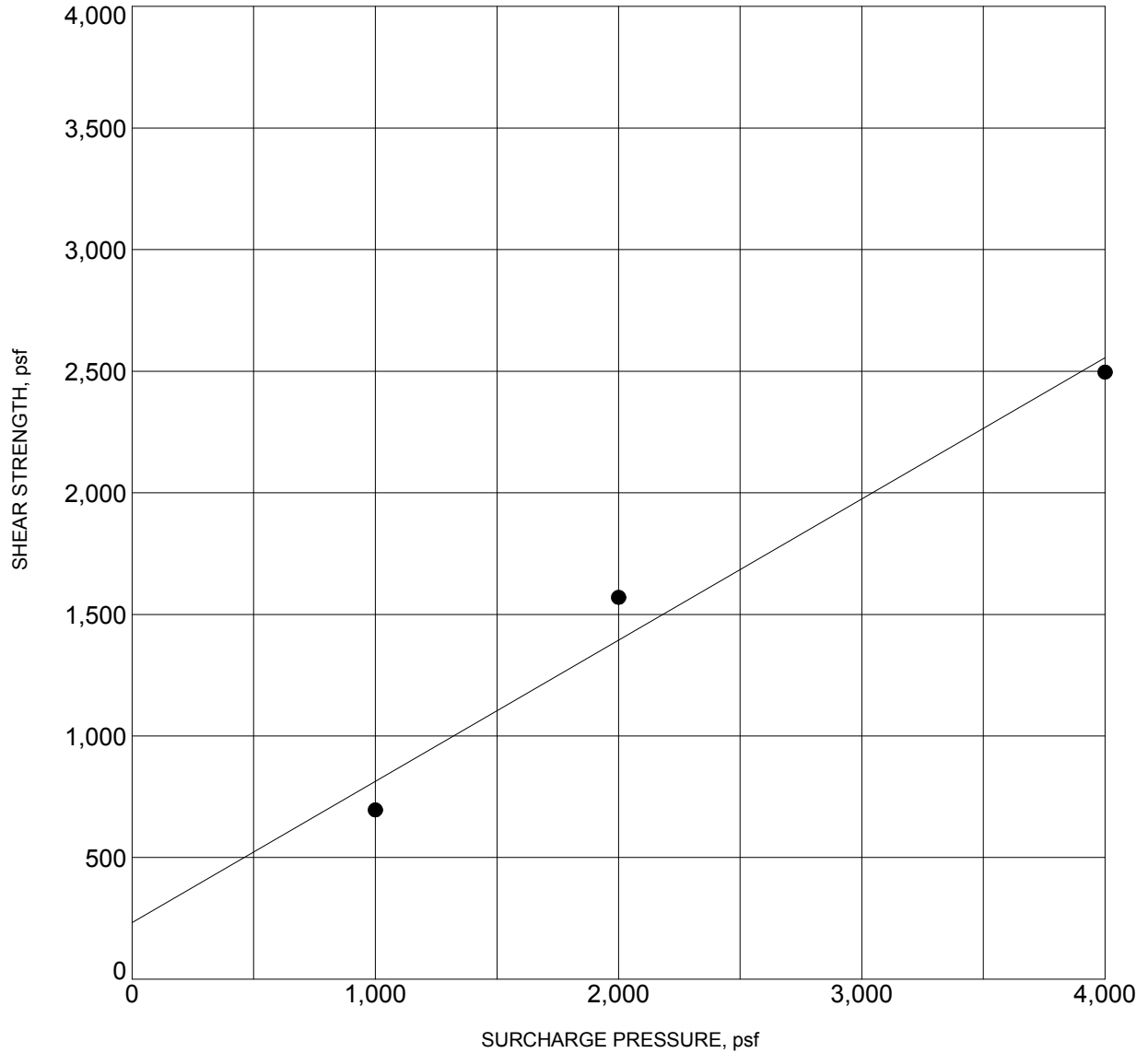

BORING NO. :	<b>BH-3</b>	DEPTH (ft) :	<b>0-5.0</b>
DESCRIPTION :	<b>CLAYEY SAND (SC)</b>		
COHESION (psf) :	<b>230</b>	FRICTION ANGLE (degrees):	<b>30</b>
MOISTURE CONTENT (%) :	<b>8.0</b>	DRY DENSITY (pcf) :	<b>122.0</b>

NOTE: Ultimate Strength.

## DIRECT SHEAR TEST RESULTS



**Converse Consultants**

Project Name  
 MT. SAN ANTONIO COLLEGE  
 STUDENT CENTER BUILDING  
 WALNUT, CALIFORNIA

Project No.  
 17-31-234-01

Figure No.  
 B-3

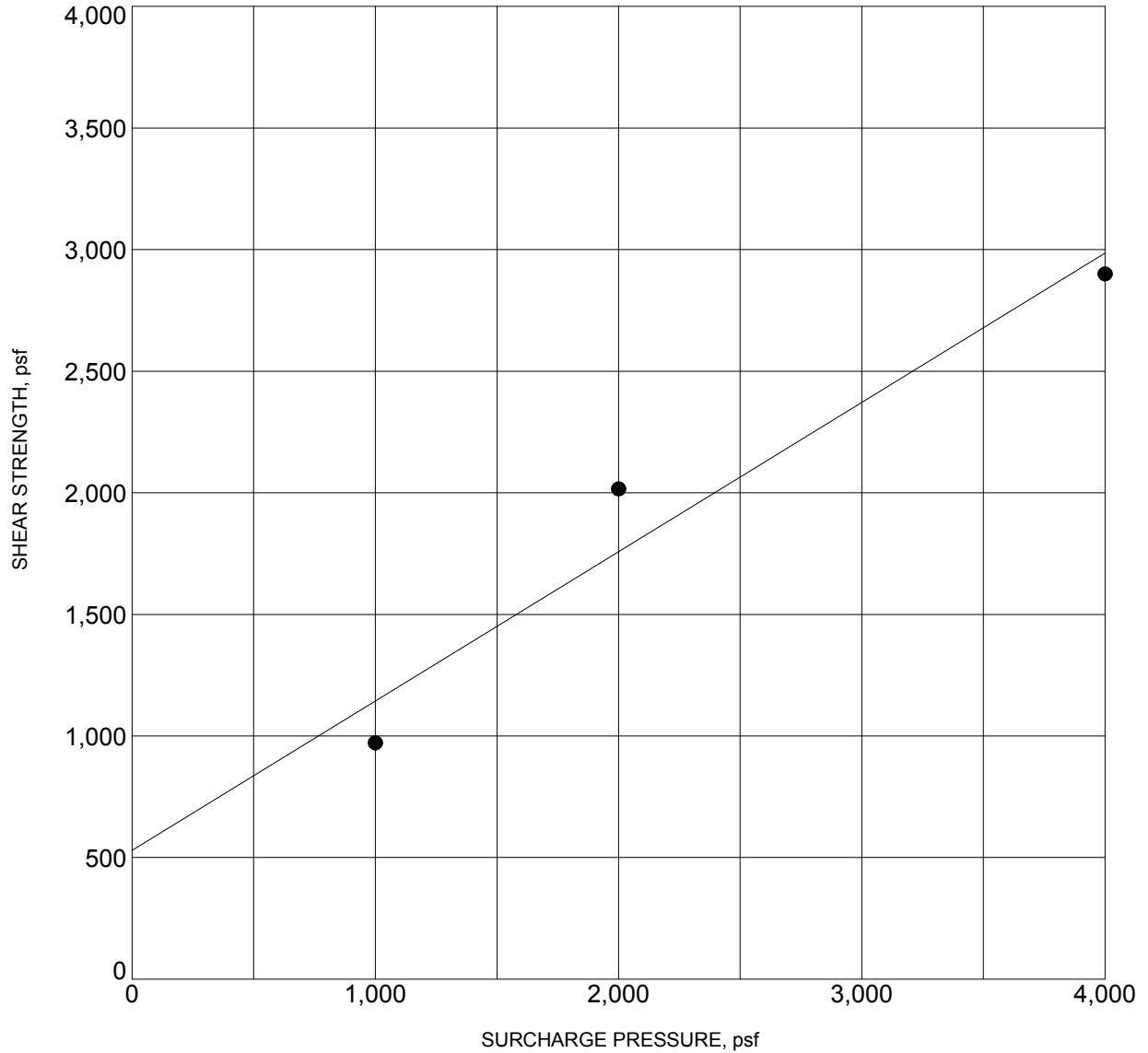

BORING NO. :	<b>BH-7</b>	DEPTH (ft) :	<b>10</b>
DESCRIPTION :	<b>CLAYEY SAND (SC)</b>		
COHESION (psf) :	<b>530</b>	FRICTION ANGLE (degrees):	<b>32</b>
MOISTURE CONTENT (%) :	<b>12.0</b>	DRY DENSITY (pcf) :	<b>115.0</b>

NOTE: Ultimate Strength.

## DIRECT SHEAR TEST RESULTS



**Converse Consultants**

Project Name  
 MT. SAN ANTONIO COLLEGE  
 STUDENT CENTER BUILDING  
 WALNUT, CALIFORNIA

Project No.  
 17-31-234-01

Figure No.  
 B-4

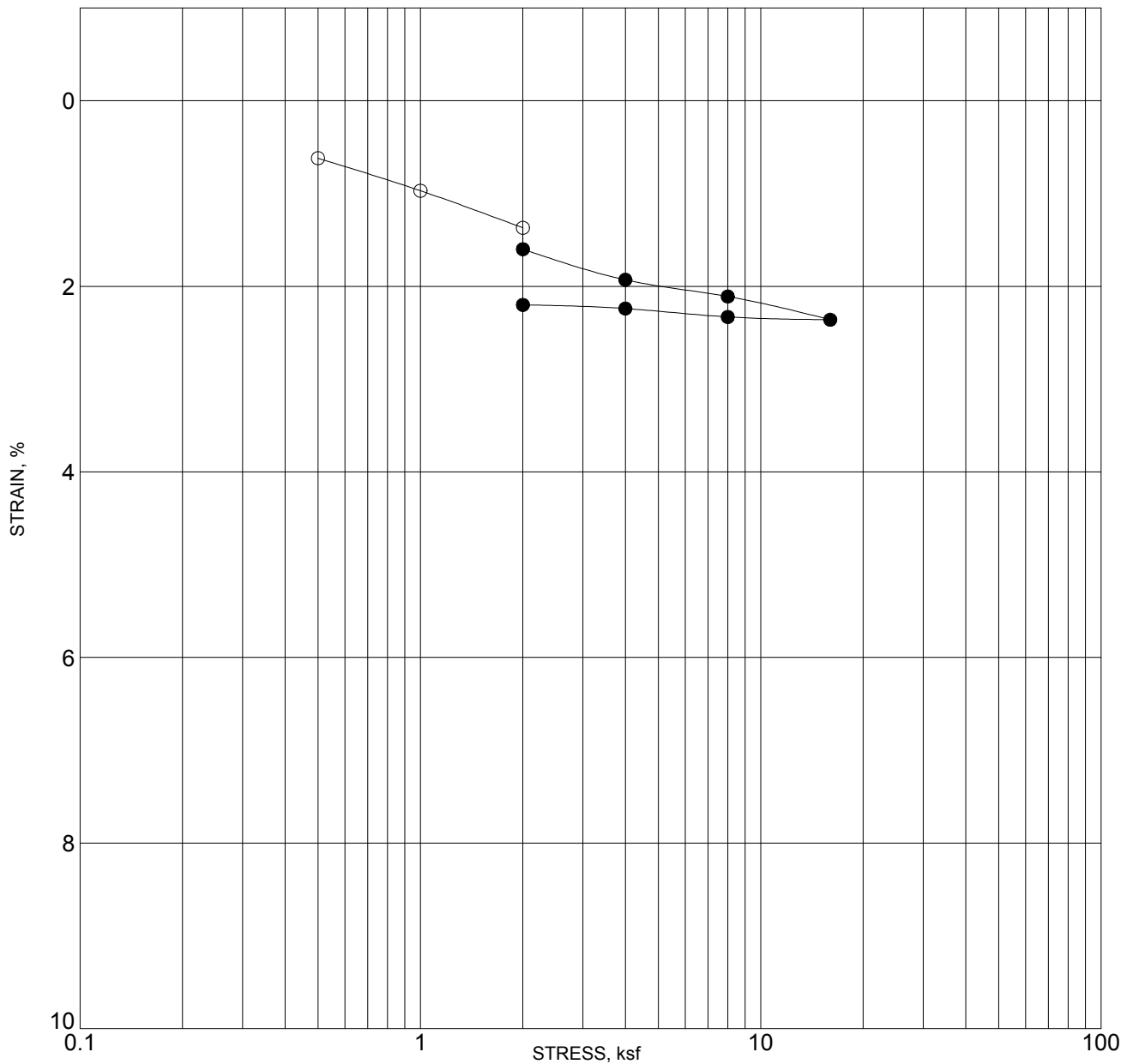

BORING NO. :		<b>BH-1</b>		DEPTH (ft) :		<b>5</b>	
DESCRIPTION :		<b>CLAYEY SAND (SC)</b>					
MOISTURE CONTENT (%)		DRY DENSITY (pcf)		PERCENT SATURATION		VOID RATIO	
INITIAL	<b>8</b>	<b>117</b>		<b>52</b>		<b>0.401</b>	
FINAL							

NOTE: SOLID CIRCLES INDICATE READINGS AFTER ADDITION OF WATER

## CONSOLIDATION TEST RESULTS



**Converse Consultants**

Project Name  
 MT. SAN ANTONIO COLLEGE  
 STUDENT CENTER BUILDING  
 WALNUT, CALIFORNIA

Project No.  
 17-31-234-01

Figure No.  
 B-5

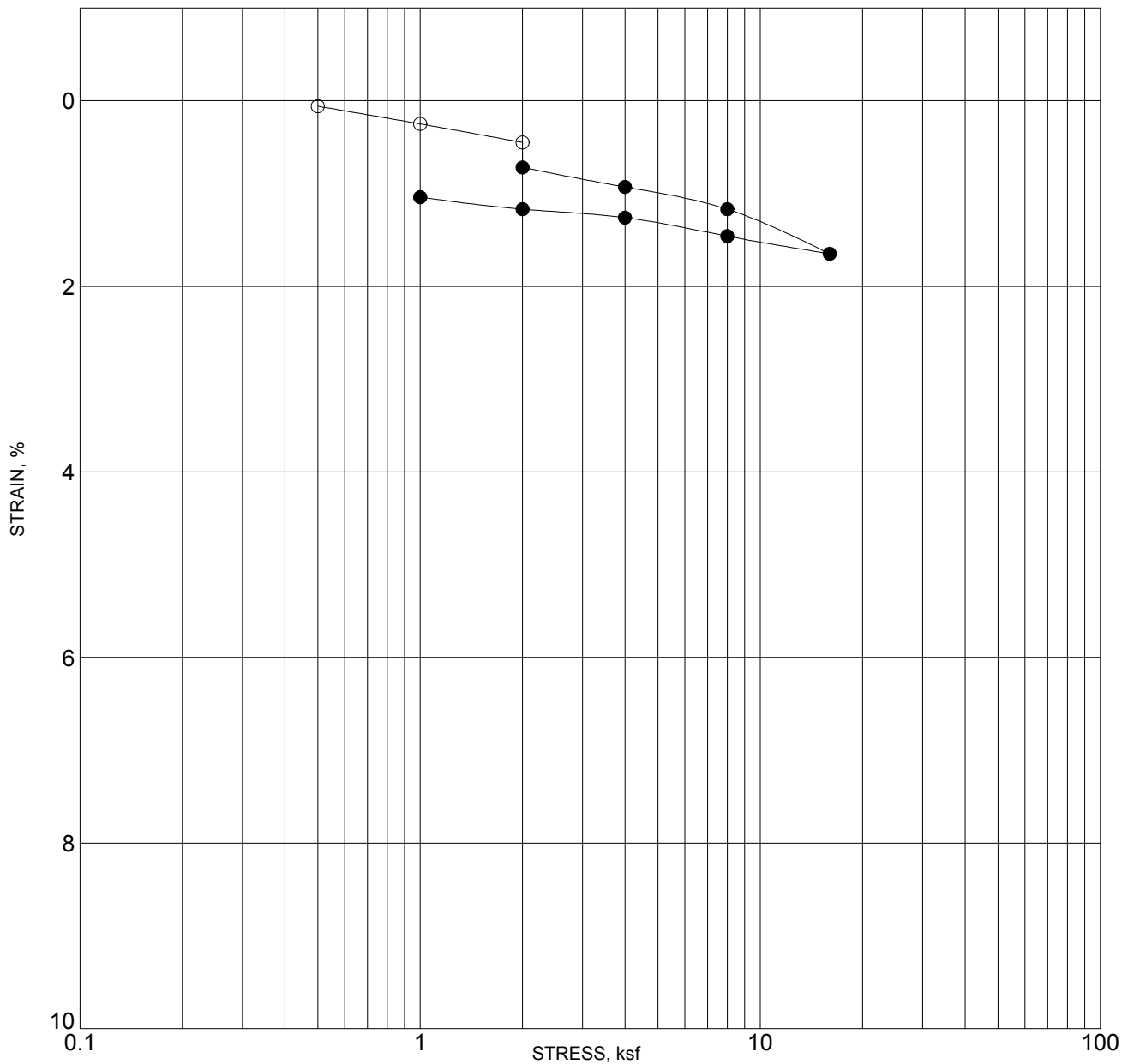

BORING NO. :		<b>BH-5</b>		DEPTH (ft) :		<b>10</b>	
DESCRIPTION :		<b>CLAYEY SAND (SC)</b>					
MOISTURE CONTENT (%)		DRY DENSITY (pcf)		PERCENT SATURATION		VOID RATIO	
INITIAL	<b>9</b>	<b>117.2</b>		<b>59</b>		<b>0.406</b>	
FINAL							

NOTE: SOLID CIRCLES INDICATE READINGS AFTER ADDITION OF WATER

## CONSOLIDATION TEST RESULTS



**Converse Consultants**

Project Name  
 MT. SAN ANTONIO COLLEGE  
 STUDENT CENTER BUILDING  
 WALNUT, CALIFORNIA

Project No.  
 17-31-234-01

Figure No.  
 B-6

# Appendix C

Liquefaction/Seismic Settlement Analysis



## APPENDIX C: LIQUEFACTION/SEISMIC SETTLEMENT ANALYSIS

Liquefaction is defined as the phenomenon where a soil mass exhibits a substantial reduction in its shear strength. This strength reduction is due to the development of excess pore pressure in a soil mass caused by earthquake induced ground motions. Saturated soils behave temporarily as a viscous fluid (liquefaction) and, consequently, lose their capacity to support the structures founded on them. The potential for liquefaction decreases with increasing clay and gravel content, but increases as the ground acceleration and duration of shaking increase. Liquefaction potential has been found to be the greatest where the groundwater level and loose sands occur within 50 feet of the ground surface.

Our liquefaction analyses are based on the *Special Publication 117A: Guidelines for Evaluating and Mitigating Seismic Hazards in California (9/2008)*, *Recommended Procedures for Implementation of DMG Special Publication 117, Guidelines for Analyzing and Mitigating Liquefaction Hazards in California (3/1999)*, and *2016 California Building Code*.

The subsurface data obtained from exploratory borings were used to evaluate the liquefaction/seismic settlement potential of the area. The Log of Borings is presented in Appendix A, *Field Exploration*. The liquefaction potential and seismic settlement analyses were performed utilizing data obtained from BH-1 for the upper 50 feet of soil. The analyses were performed using *LiquefyPro*, Version 5.8n, 2012, by Civil Tech Software. The following seismic parameters are used for liquefaction potential analyses.

**Table No. C-1, Seismic Parameters Used in Liquefaction Analysis**

Groundwater Depth* (feet)	Earthquake Magnitude** Mw	Peak Ground Acceleration** (g)
50	6.89	0.777

\* Based on Seismic Hazard Zone Report for the San Dimas 7.5-Minute Quadrangle

\*\* Based on results from site specific analysis using EZ-FRISK by Risk Engineering (v. 7.62) and the 2008 USGS Fault Model database

We understand that the proposed new student center building will be a single three-story structure. The existing topography shows that current elevation of the building footprint is from 757 feet to 771 feet. BH-1 is at an existing elevation of 769 feet and BH-5 is at an existing elevation of 764 feet.

The final grade will be at an approximate elevation of 757 feet. This implies that approximately 12 feet of soil will be excavated below BH-1 and an additional five feet of soil will be over-excavated and recompacted.

Similarly, BH-5 will have approximately seven feet of soil excavated beneath with an additional five feet of soil that will be over-excavated and recompacted to provide a firm bottom for the foundations.

From this, we have assumed an SPT blow count of 50 for the top 15 feet of soil for BH-1 and the top 10 feet of soil for BH-5 for our analysis as there will be no settlement from this portion of soil, as it will either be removed, or recompacted. Please see the following table for the results of our liquefaction analysis.

**Table No. C-2, Potential Seismic Settlement Results**

Boring	Potential Dry Seismic Settlement (inch)	Potential Differential Settlement (inch)
BH-1	1.55	0.78
BH-5	1.67	0.84

The results of liquefaction analyses indicate the site soils are not susceptible to liquefaction.

# LIQUEFACTION ANALYSIS

## Mt. SAC Student Center Building

**Hole No.=BH-1    Water Depth=50 ft**

**Magnitude=6.89  
Acceleration=0.777g**

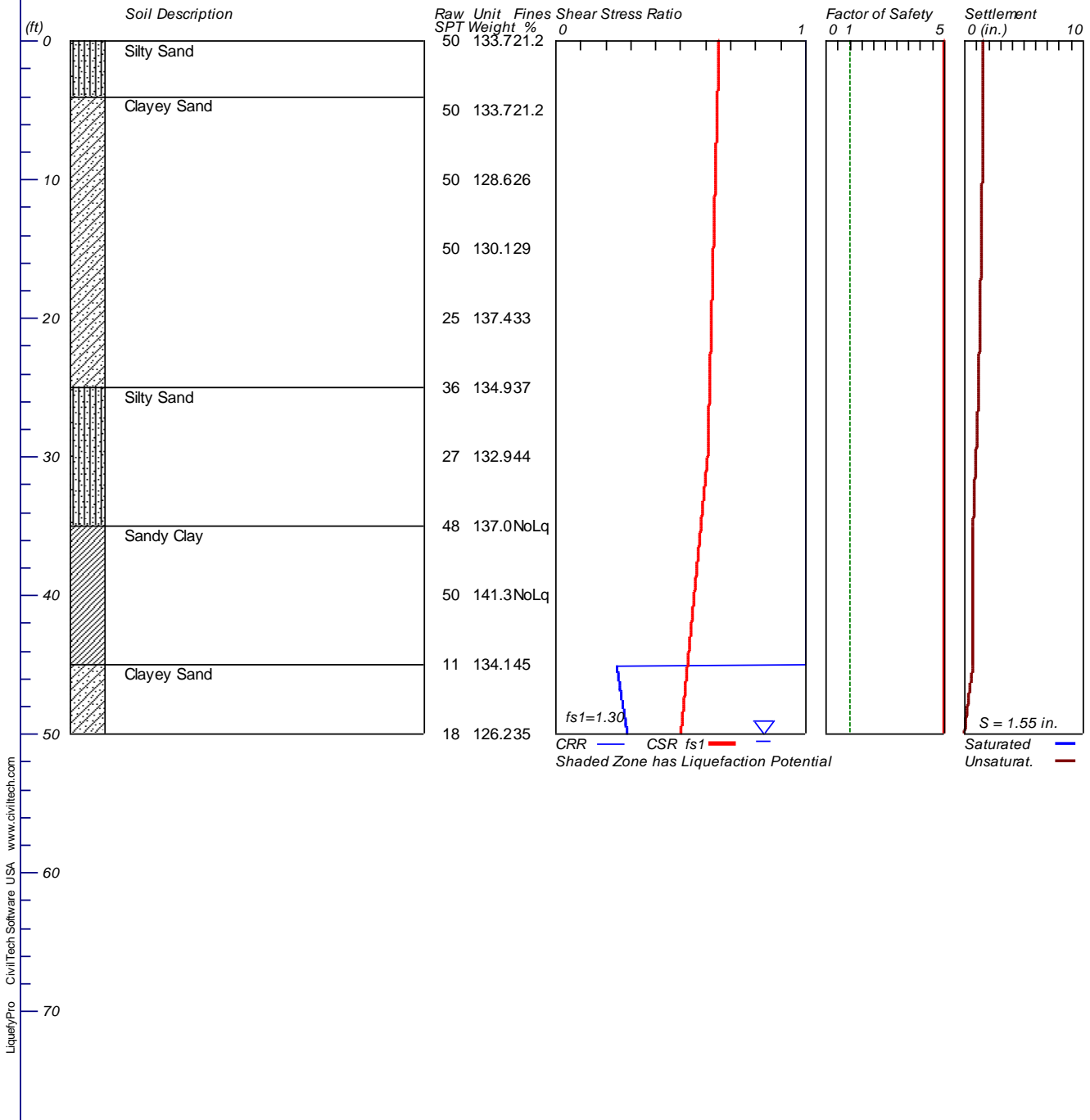

LiquefyPro CivilTech Software USA www.civilttech.com

\*\*\*\*\*  
\*\*\*\*\*

LIQUEFACTION ANALYSIS SUMMARY

Copyright by CivilTech Software  
www.civiltechsoftware.com

\*\*\*\*\*  
\*\*\*\*\*

Font: Courier New, Regular, Size 8 is recommended for this report.  
Licensed to , 10/5/2017 1:19:49 PM

Input File Name: C:\Liquefy5\17-31-234-01 BH-1 Liq.liq  
Title: Mt. SAC Student Center Building  
Subtitle: 17-31-234-01

Surface Elev.=  
Hole No.=BH-1  
Depth of Hole= 50.00 ft  
Water Table during Earthquake= 50.00 ft  
Water Table during In-Situ Testing= 50.00 ft  
Max. Acceleration= 0.78 g  
Earthquake Magnitude= 6.89

Input Data:

Surface Elev.=  
Hole No.=BH-1  
Depth of Hole=50.00 ft  
Water Table during Earthquake= 50.00 ft  
Water Table during In-Situ Testing= 50.00 ft  
Max. Acceleration=0.78 g  
Earthquake Magnitude=6.89

1. SPT or BPT Calculation.
  2. Settlement Analysis Method: Ishihara / Yoshimine
  3. Fines Correction for Liquefaction: Modify Stark/Olson
  4. Fine Correction for Settlement: During Liquefaction\*
  5. Settlement Calculation in: All zones\*
  6. Hammer Energy Ratio, Ce = 1.25
  7. Borehole Diameter, Cb= 1.15
  8. Sampling Method, Cs= 1.2
  9. User request factor of safety (apply to CSR) , User= 1.3  
Plot one CSR curve (fs1=User)
  10. Use Curve Smoothing: Yes\*
- \* Recommended Options

17-31-234-01 BH-1 Liq.sum

In-Situ Test Data:

Depth ft	SPT	gamma pcf	Fines %
0.00	50.00	133.70	21.20
5.00	50.00	133.70	21.20
10.00	50.00	128.60	26.00
15.00	50.00	130.10	29.00
20.00	25.00	137.40	33.00
25.00	36.00	134.90	37.00
30.00	27.00	132.90	44.00
35.00	48.00	137.00	NoLiq
40.00	50.00	141.30	NoLiq
45.00	11.00	134.10	45.00
50.00	18.00	126.20	35.00

Output Results:

Settlement of Saturated Sands=0.00 in.  
 Settlement of Unsaturated Sands=1.55 in.  
 Total Settlement of Saturated and Unsaturated Sands=1.55 in.  
 Differential Settlement=0.776 to 1.025 in.

Depth ft	CRRm	CSRfs	F.S.	S_sat. in.	S_dry in.	S_all in.
0.00	2.48	0.66	5.00	0.00	1.55	1.55
0.50	2.48	0.66	5.00	0.00	1.55	1.55
1.00	2.48	0.66	5.00	0.00	1.55	1.55
1.50	2.48	0.65	5.00	0.00	1.55	1.55
2.00	2.48	0.65	5.00	0.00	1.55	1.55
2.50	2.48	0.65	5.00	0.00	1.55	1.55
3.00	2.48	0.65	5.00	0.00	1.55	1.55
3.50	2.48	0.65	5.00	0.00	1.55	1.55
4.00	2.48	0.65	5.00	0.00	1.55	1.55
4.50	2.48	0.65	5.00	0.00	1.54	1.54
5.00	2.48	0.65	5.00	0.00	1.54	1.54
5.50	2.48	0.65	5.00	0.00	1.54	1.54
6.00	2.48	0.65	5.00	0.00	1.54	1.54
6.50	2.48	0.65	5.00	0.00	1.54	1.54
7.00	2.48	0.65	5.00	0.00	1.53	1.53
7.50	2.48	0.65	5.00	0.00	1.53	1.53
8.00	2.48	0.64	5.00	0.00	1.52	1.52
8.50	2.48	0.64	5.00	0.00	1.52	1.52
9.00	2.48	0.64	5.00	0.00	1.52	1.52
9.50	2.48	0.64	5.00	0.00	1.51	1.51
10.00	2.48	0.64	5.00	0.00	1.51	1.51
10.50	2.48	0.64	5.00	0.00	1.51	1.51

17-31-234-01 BH-1 Liq.sum

11.00	2.48	0.64	5.00	0.00	1.50	1.50
11.50	2.48	0.64	5.00	0.00	1.50	1.50
12.00	2.48	0.64	5.00	0.00	1.49	1.49
12.50	2.48	0.64	5.00	0.00	1.49	1.49
13.00	2.48	0.64	5.00	0.00	1.48	1.48
13.50	2.48	0.64	5.00	0.00	1.47	1.47
14.00	2.48	0.64	5.00	0.00	1.46	1.46
14.50	2.48	0.63	5.00	0.00	1.46	1.46
15.00	2.48	0.63	5.00	0.00	1.45	1.45
15.50	2.48	0.63	5.00	0.00	1.44	1.44
16.00	2.48	0.63	5.00	0.00	1.43	1.43
16.50	2.48	0.63	5.00	0.00	1.41	1.41
17.00	2.48	0.63	5.00	0.00	1.39	1.39
17.50	2.48	0.63	5.00	0.00	1.37	1.37
18.00	2.48	0.63	5.00	0.00	1.36	1.36
18.50	2.48	0.63	5.00	0.00	1.36	1.36
19.00	2.48	0.63	5.00	0.00	1.35	1.35
19.50	2.48	0.63	5.00	0.00	1.34	1.34
20.00	2.48	0.63	5.00	0.00	1.33	1.33
20.50	2.48	0.63	5.00	0.00	1.31	1.31
21.00	2.48	0.62	5.00	0.00	1.30	1.30
21.50	2.48	0.62	5.00	0.00	1.29	1.29
22.00	2.48	0.62	5.00	0.00	1.28	1.28
22.50	2.48	0.62	5.00	0.00	1.26	1.26
23.00	2.48	0.62	5.00	0.00	1.25	1.25
23.50	2.49	0.62	5.00	0.00	1.24	1.24
24.00	2.49	0.62	5.00	0.00	1.22	1.22
24.50	2.48	0.62	5.00	0.00	1.21	1.21
25.00	2.47	0.62	5.00	0.00	1.19	1.19
25.50	2.46	0.62	5.00	0.00	1.18	1.18
26.00	2.45	0.62	5.00	0.00	1.16	1.16
26.50	2.44	0.62	5.00	0.00	1.15	1.15
27.00	2.44	0.62	5.00	0.00	1.13	1.13
27.50	2.43	0.61	5.00	0.00	1.11	1.11
28.00	2.42	0.61	5.00	0.00	1.09	1.09
28.50	2.41	0.61	5.00	0.00	1.06	1.06
29.00	2.40	0.61	5.00	0.00	1.04	1.04
29.50	2.40	0.61	5.00	0.00	1.01	1.01
30.00	2.39	0.61	5.00	0.00	0.98	0.98
30.50	2.38	0.61	5.00	0.00	0.95	0.95
31.00	2.37	0.61	5.00	0.00	0.92	0.92
31.50	2.36	0.60	5.00	0.00	0.90	0.90
32.00	2.36	0.60	5.00	0.00	0.87	0.87
32.50	2.35	0.60	5.00	0.00	0.85	0.85
33.00	2.34	0.59	5.00	0.00	0.83	0.83
33.50	2.33	0.59	5.00	0.00	0.81	0.81
34.00	2.33	0.59	5.00	0.00	0.79	0.79
34.50	2.32	0.59	5.00	0.00	0.77	0.77



17-31-234-01 BH-1 Liq.sum

35.00	2.31	0.58	5.00	0.00	0.76	0.76
35.50	2.00	0.58	5.00	0.00	0.76	0.76
36.00	2.00	0.58	5.00	0.00	0.76	0.76
36.50	2.00	0.58	5.00	0.00	0.76	0.76
37.00	2.00	0.57	5.00	0.00	0.76	0.76
37.50	2.00	0.57	5.00	0.00	0.76	0.76
38.00	2.00	0.57	5.00	0.00	0.76	0.76
38.50	2.00	0.57	5.00	0.00	0.76	0.76
39.00	2.00	0.56	5.00	0.00	0.76	0.76
39.50	2.00	0.56	5.00	0.00	0.76	0.76
40.00	2.00	0.56	5.00	0.00	0.76	0.76
40.50	2.00	0.55	5.00	0.00	0.76	0.76
41.00	2.00	0.55	5.00	0.00	0.76	0.76
41.50	2.00	0.55	5.00	0.00	0.76	0.76
42.00	2.00	0.55	5.00	0.00	0.76	0.76
42.50	2.00	0.54	5.00	0.00	0.76	0.76
43.00	2.00	0.54	5.00	0.00	0.76	0.76
43.50	2.00	0.54	5.00	0.00	0.76	0.76
44.00	2.00	0.54	5.00	0.00	0.76	0.76
44.50	2.00	0.53	5.00	0.00	0.76	0.76
45.00	2.00	0.53	5.00	0.00	0.76	0.76
45.50	0.25	0.53	5.00	0.00	0.67	0.67
46.00	0.25	0.53	5.00	0.00	0.58	0.58
46.50	0.25	0.52	5.00	0.00	0.50	0.50
47.00	0.26	0.52	5.00	0.00	0.42	0.42
47.50	0.26	0.52	5.00	0.00	0.34	0.34
48.00	0.27	0.51	5.00	0.00	0.27	0.27
48.50	0.27	0.51	5.00	0.00	0.20	0.20
49.00	0.28	0.51	5.00	0.00	0.13	0.13
49.50	0.28	0.51	5.00	0.00	0.06	0.06
50.00	0.29	0.50	5.00	0.00	0.00	0.00

\* F.S.<1, Liquefaction Potential Zone  
(F.S. is limited to 5, CRR is limited to 2, CSR is limited to 2)

Units: Depth = ft, Stress or Pressure = atm (tsf), Unit Weight = pcf,  
Settlement = in.

---

1 atm (atmosphere) = 1 tsf (ton/ft <sup>2</sup> )
CRRm                      Cyclic resistance ratio from soils
CSRsf                     Cyclic stress ratio induced by a given earthquake (with user request factor of safety)
F.S.                        Factor of Safety against liquefaction, F.S.=CRRm/CSRsf
S_sat                      Settlement from saturated sands
S_dry                      Settlement from Unsaturated Sands
S_all                      Total Settlement from Saturated and Unsaturated Sands
NoLiq                     No-Liquefy Soils

17-31-234-01 BH-1 Liq.sum

# LIQUEFACTION ANALYSIS

## Mt. SAC Student Center Building

**Hole No.=BH-5    Water Depth=47.5 ft**

**Magnitude=6.89  
Acceleration=0.777g**

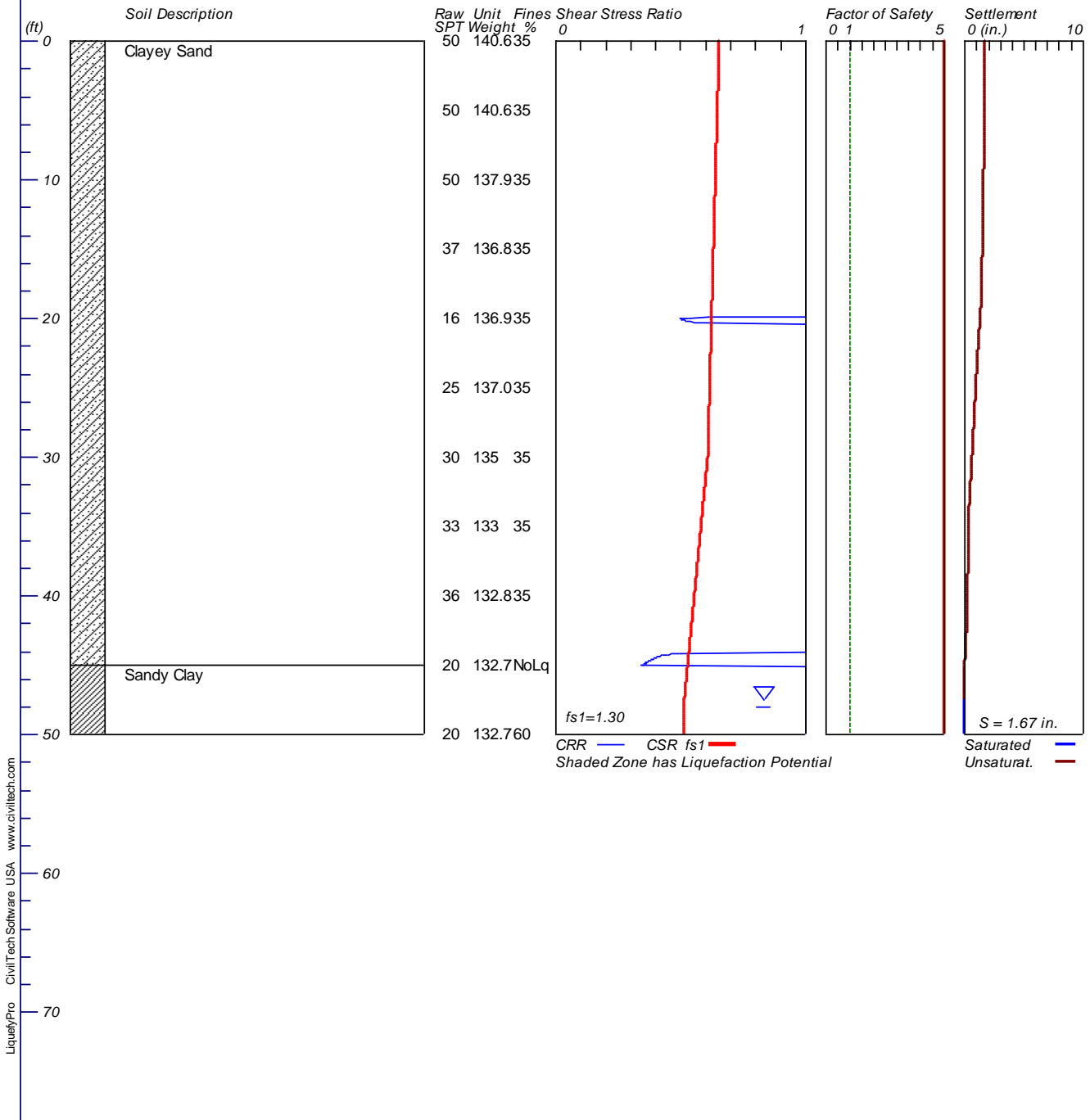

LiquefyPro CivilTech Software USA www.civilttech.com

\*\*\*\*\*  
\*\*\*\*\*

LIQUEFACTION ANALYSIS SUMMARY

Copyright by CivilTech Software  
www.civiltechsoftware.com

\*\*\*\*\*  
\*\*\*\*\*

Font: Courier New, Regular, Size 8 is recommended for this report.  
Licensed to , 10/5/2017 2:45:43 PM

Input File Name: C:\Liquefy5\17-31-234-01 BH-5 Liq.liq  
Title: Mt. SAC Student Center Building  
Subtitle: 17-31-234-01

Surface Elev.=  
Hole No.=BH-5  
Depth of Hole= 50.00 ft  
Water Table during Earthquake= 47.50 ft  
Water Table during In-Situ Testing= 47.50 ft  
Max. Acceleration= 0.78 g  
Earthquake Magnitude= 6.89

Input Data:

Surface Elev.=  
Hole No.=BH-5  
Depth of Hole=50.00 ft  
Water Table during Earthquake= 47.50 ft  
Water Table during In-Situ Testing= 47.50 ft  
Max. Acceleration=0.78 g  
Earthquake Magnitude=6.89

1. SPT or BPT Calculation.
  2. Settlement Analysis Method: Ishihara / Yoshimine
  3. Fines Correction for Liquefaction: Stark/Olson et al.\*
  4. Fine Correction for Settlement: During Liquefaction\*
  5. Settlement Calculation in: All zones\*
  6. Hammer Energy Ratio, Ce = 1.25
  7. Borehole Diameter, Cb= 1.15
  8. Sampling Method, Cs= 1.2
  9. User request factor of safety (apply to CSR) , User= 1.3  
Plot one CSR curve (fs1=User)
  10. Use Curve Smoothing: Yes\*
- \* Recommended Options

17-31-234-01 BH-5 Liq.sum

In-Situ Test Data:

Depth ft	SPT	gamma pcf	Fines %
0.00	50.00	140.60	35.00
5.00	50.00	140.60	35.00
10.00	50.00	137.90	35.00
15.00	37.00	136.80	35.00
20.00	16.00	136.90	35.00
25.00	25.00	137.00	35.00
30.00	30.00	135.00	35.00
35.00	33.00	133.00	35.00
40.00	36.00	132.80	35.00
45.00	20.00	132.70	NoLiq
50.00	20.00	132.70	60.00

Output Results:

Settlement of Saturated Sands=0.00 in.

Settlement of Unsaturated Sands=1.67 in.

Total Settlement of Saturated and Unsaturated Sands=1.67 in.

Differential Settlement=0.834 to 1.101 in.

Depth ft	CRRm	CSRfs	F.S.	S_sat. in.	S_dry in.	S_all in.
0.00	2.48	0.66	5.00	0.00	1.67	1.67
0.50	2.48	0.66	5.00	0.00	1.67	1.67
1.00	2.48	0.66	5.00	0.00	1.67	1.67
1.50	2.48	0.65	5.00	0.00	1.67	1.67
2.00	2.48	0.65	5.00	0.00	1.67	1.67
2.50	2.48	0.65	5.00	0.00	1.66	1.66
3.00	2.48	0.65	5.00	0.00	1.66	1.66
3.50	2.48	0.65	5.00	0.00	1.66	1.66
4.00	2.48	0.65	5.00	0.00	1.66	1.66
4.50	2.48	0.65	5.00	0.00	1.66	1.66
5.00	2.48	0.65	5.00	0.00	1.66	1.66
5.50	2.48	0.65	5.00	0.00	1.66	1.66
6.00	2.48	0.65	5.00	0.00	1.65	1.65
6.50	2.48	0.65	5.00	0.00	1.65	1.65
7.00	2.48	0.65	5.00	0.00	1.65	1.65
7.50	2.48	0.65	5.00	0.00	1.64	1.64
8.00	2.48	0.64	5.00	0.00	1.64	1.64
8.50	2.48	0.64	5.00	0.00	1.63	1.63
9.00	2.48	0.64	5.00	0.00	1.63	1.63
9.50	2.48	0.64	5.00	0.00	1.63	1.63
10.00	2.48	0.64	5.00	0.00	1.62	1.62
10.50	2.48	0.64	5.00	0.00	1.62	1.62

17-31-234-01 BH-5 Liq.sum

11.00	2.48	0.64	5.00	0.00	1.61	1.61
11.50	2.48	0.64	5.00	0.00	1.61	1.61
12.00	2.48	0.64	5.00	0.00	1.60	1.60
12.50	2.48	0.64	5.00	0.00	1.59	1.59
13.00	2.48	0.64	5.00	0.00	1.59	1.59
13.50	2.48	0.64	5.00	0.00	1.57	1.57
14.00	2.48	0.64	5.00	0.00	1.56	1.56
14.50	2.48	0.63	5.00	0.00	1.55	1.55
15.00	2.48	0.63	5.00	0.00	1.53	1.53
15.50	2.48	0.63	5.00	0.00	1.51	1.51
16.00	2.48	0.63	5.00	0.00	1.49	1.49
16.50	2.48	0.63	5.00	0.00	1.46	1.46
17.00	2.48	0.63	5.00	0.00	1.44	1.44
17.50	2.48	0.63	5.00	0.00	1.43	1.43
18.00	2.48	0.63	5.00	0.00	1.42	1.42
18.50	2.48	0.63	5.00	0.00	1.41	1.41
19.00	2.48	0.63	5.00	0.00	1.40	1.40
19.50	2.48	0.63	5.00	0.00	1.37	1.37
20.00	0.50	0.63	5.00	0.00	1.33	1.33
20.50	2.48	0.63	5.00	0.00	1.29	1.29
21.00	2.48	0.62	5.00	0.00	1.24	1.24
21.50	2.48	0.62	5.00	0.00	1.20	1.20
22.00	2.48	0.62	5.00	0.00	1.16	1.16
22.50	2.50	0.62	5.00	0.00	1.12	1.12
23.00	2.49	0.62	5.00	0.00	1.09	1.09
23.50	2.48	0.62	5.00	0.00	1.05	1.05
24.00	2.47	0.62	5.00	0.00	1.02	1.02
24.50	2.46	0.62	5.00	0.00	0.99	0.99
25.00	2.45	0.62	5.00	0.00	0.95	0.95
25.50	2.44	0.62	5.00	0.00	0.92	0.92
26.00	2.43	0.62	5.00	0.00	0.89	0.89
26.50	2.43	0.62	5.00	0.00	0.86	0.86
27.00	2.42	0.62	5.00	0.00	0.83	0.83
27.50	2.41	0.61	5.00	0.00	0.80	0.80
28.00	2.40	0.61	5.00	0.00	0.77	0.77
28.50	2.39	0.61	5.00	0.00	0.74	0.74
29.00	2.39	0.61	5.00	0.00	0.71	0.71
29.50	2.38	0.61	5.00	0.00	0.67	0.67
30.00	2.37	0.61	5.00	0.00	0.64	0.64
30.50	2.36	0.61	5.00	0.00	0.61	0.61
31.00	2.36	0.61	5.00	0.00	0.57	0.57
31.50	2.35	0.60	5.00	0.00	0.54	0.54
32.00	2.34	0.60	5.00	0.00	0.51	0.51
32.50	2.33	0.60	5.00	0.00	0.47	0.47
33.00	2.33	0.59	5.00	0.00	0.44	0.44
33.50	2.32	0.59	5.00	0.00	0.40	0.40
34.00	2.31	0.59	5.00	0.00	0.39	0.39
34.50	2.30	0.59	5.00	0.00	0.38	0.38



17-31-234-01 BH-5 Liq.sum

35.00	2.30	0.58	5.00	0.00	0.36	0.36
35.50	2.29	0.58	5.00	0.00	0.35	0.35
36.00	2.28	0.58	5.00	0.00	0.34	0.34
36.50	2.28	0.58	5.00	0.00	0.33	0.33
37.00	2.27	0.57	5.00	0.00	0.32	0.32
37.50	2.26	0.57	5.00	0.00	0.30	0.30
38.00	2.26	0.57	5.00	0.00	0.29	0.29
38.50	2.25	0.57	5.00	0.00	0.28	0.28
39.00	2.24	0.56	5.00	0.00	0.27	0.27
39.50	2.24	0.56	5.00	0.00	0.26	0.26
40.00	2.23	0.56	5.00	0.00	0.24	0.24
40.50	2.22	0.55	5.00	0.00	0.23	0.23
41.00	2.22	0.55	5.00	0.00	0.22	0.22
41.50	2.21	0.55	5.00	0.00	0.20	0.20
42.00	2.20	0.55	5.00	0.00	0.19	0.19
42.50	2.20	0.54	5.00	0.00	0.17	0.17
43.00	2.19	0.54	5.00	0.00	0.14	0.14
43.50	2.19	0.54	5.00	0.00	0.12	0.12
44.00	2.18	0.54	5.00	0.00	0.09	0.09
44.50	0.39	0.53	5.00	0.00	0.05	0.05
45.00	0.34	0.53	5.00	0.00	0.00	0.00
45.50	2.00	0.53	5.00	0.00	0.00	0.00
46.00	2.00	0.53	5.00	0.00	0.00	0.00
46.50	2.00	0.52	5.00	0.00	0.00	0.00
47.00	2.00	0.52	5.00	0.00	0.00	0.00
47.50	2.00	0.52	5.00	0.00	0.00	0.00
48.00	2.00	0.52	5.00	0.00	0.00	0.00
48.50	2.00	0.52	5.00	0.00	0.00	0.00
49.00	2.00	0.52	5.00	0.00	0.00	0.00
49.50	2.00	0.52	5.00	0.00	0.00	0.00
50.00	2.00	0.52	5.00	0.00	0.00	0.00

\* F.S.<1, Liquefaction Potential Zone  
(F.S. is limited to 5, CRR is limited to 2, CSR is limited to 2)

Units: Depth = ft, Stress or Pressure = atm (tsf), Unit Weight = pcf,  
Settlement = in.

---

1 atm (atmosphere) = 1 tsf (ton/ft <sup>2</sup> )
CRRm                      Cyclic resistance ratio from soils
CSRsf                     Cyclic stress ratio induced by a given earthquake (with user request factor of safety)
F.S.                        Factor of Safety against liquefaction, F.S.=CRRm/CSRsf
S_sat                      Settlement from saturated sands
S_dry                      Settlement from Unsaturated Sands
S_all                      Total Settlement from Saturated and Unsaturated Sands
NoLiq                     No-Liquefy Soils

17-31-234-01 BH-5 Liq.sum

# Appendix D

Earthwork Specifications

## **APPENDIX D: EARTHWORK SPECIFICATIONS**

### ***D1.1 Scope of Work***

The work includes all labor, supplies and construction equipment required to construct the building pads in a good, workman-like manner, as shown on the drawings and herein specified. The major items of work covered in this section include the following:

- Site Inspection
- Authority of Geotechnical Engineer
- Site Clearing
- Excavations
- Preparation of Fill Areas
- Placement and Compaction of Fill
- Observation and Testing

### ***D1.2 Site Inspection***

- The Contractor shall carefully examine the site and make all inspections necessary, in order to determine the full extent of the work required to make the completed work conform to the drawings and specifications. The Contractor shall satisfy himself as to the nature and location of the work, ground surface and the characteristics of equipment and facilities needed prior to and during prosecution of the work. The Contractor shall satisfy himself as to the character, quality, and quantity of surface and subsurface materials or obstacles to be encountered. Any inaccuracies or discrepancies between the actual field conditions and the drawings, or between the drawings and specifications must be brought to the Owner's attention in order to clarify the exact nature of the work to be performed.
- This *Geotechnical Study Report* by Converse Consultants may be used as a reference to the surface and subsurface conditions on this project. The information presented in this report is intended for use in design and is subject to confirmation of the conditions encountered during construction. The exploration logs and related information depict subsurface conditions only at the particular time and location designated on the boring logs. Subsurface conditions at other locations may differ from conditions encountered at the exploration locations. In addition, the passage of time may result in a change in subsurface conditions at the exploration locations. Any review of this information shall not relieve the Contractor from performing such independent investigation and evaluation to satisfy himself as to the nature of the surface and subsurface conditions to be encountered and the procedures to be used in performing his work.

### ***D1.3 Authority of the Geotechnical Engineer***

- The Geotechnical Engineer will observe the placement of compacted fill and will take sufficient tests to evaluate the uniformity and degree of compaction of filled ground.
- As the Owner's representative, the Geotechnical Engineer will (a) have the authority to cause the removal and replacement of loose, soft, disturbed and other unsatisfactory soils and uncontrolled fill; (b) have the authority to approve the preparation of native ground to receive fill material; and (c) have the authority to approve or reject soils proposed for use in building areas.
- The Civil Engineer and/or Owner will decide all questions regarding (a) the interpretation of the drawings and specifications, (b) the acceptable fulfillment of the contract on the part of the Contractor and (c) the matters of compensation.

### ***D1.4 Site Clearing***

- Clearing and grubbing shall consist of the removal from building areas to be graded of all existing structures, pavements, utilities, trees, vegetation and roots.
- Organic and inorganic materials resulting from the clearing and grubbing operations shall be hauled away from the areas to be graded.

### ***D1.5 Excavations***

- Based on observations made during our field explorations, the surficial soils can be excavated with conventional earthwork equipment.

### ***D1.6 Preparation of Fill Areas***

- All organic material, organic soils, incompetent alluvium, undocumented fill soils and debris should be removed from the proposed building areas.
- In order to provide uniform support for the new structures, the minimum depth of over-excavation should be five (5) feet below the existing grade, or 36 inches below proposed bottom of foundations whichever is deeper. Deeper over-excavation will be needed if soft, yielding soils are exposed on the excavation bottom.
- The bottoms should be founded on firm and unyielding native soils or properly compacted fills. The final bottom surfaces of all excavations shall be observed and approved by the project geotechnical engineer or his representative prior to placing any compacted fill. All compacted fills should be placed on competent native

materials or properly compacted fill as determined by the project geotechnical engineer or his representative. The actual depth of removal should be determined based on observations made during grading. Over-excavation and recompaction should extend a least five (5) feet beyond the limits of footings, or equal distance of over-excavation depth, whichever is greater, or as limited by the existing structures. Excavation activities should not disturb existing utilities, buildings, and remaining structures.

- Existing utilities should be removed and adequately capped at the project boundary line, or salvaged/rerouted as designed for sidewalks and flatwork area, at least the upper 24 inches of existing soils should be scarified and recompacted to at least 90 percent of compaction. Deeper over-excavation will be needed if soft, yielding soils are exposed on the excavation bottom. The excavation should be extended to at least 12 inches beyond the driveway and flatwork limit where space is permitted.
- The subgrade in all areas to receive fill shall be scarified to a minimum depth of six inches, the soil moisture adjusted to above three percent (3%) of the optimum moisture content for fine-grained soils and within three percent (3%) of the optimum moisture content for granular soils, mixed and then compacted to at least 90 percent of the laboratory maximum dry density as determined by ASTM Standard D1557 test method.
- Compacted fill may be placed on native soils that have been properly scarified and re-compacted as discussed above.
- All areas to receive compacted fill will be observed and approved by the project Geotechnical Engineer or his designated representative before the placement of fill.

#### ***D1.7 Placement and Compaction of Fill***

- Compacted fill placed for the support of footings, slabs-on-grade, exterior concrete flatwork, and driveways will be considered structural fill. Structural fill may consist of approved on-site soils or imported fill that meets the criteria indicated below.
- Fill consisting of selected on-site earth materials or imported soils approved by the project Geotechnical Engineer or his designated representative shall be placed in layers on approved earth materials. Soils used as compacted structural fill shall have the following characteristics:
  - All fill soil particles shall not exceed three (3) inches in nominal size, and shall be free of organic matter and miscellaneous inorganic debris and inert rubble.



Rocks larger than three (3) inches in size may be encountered during grading and should be anticipated in the underlying sediments.

- Imported fill materials shall have an Expansion Index (EI) less than 20. All imported fill should be compacted to at least 90 percent of the laboratory maximum dry density (ASTM Standard D1557) within three (3) percent of the optimum moisture.
- Fill soils shall be evenly spread in maximum 8-inch lifts, watered or dried as necessary, mixed and compacted to at least the density specified below. The fill shall be placed and compacted on a horizontal plane, unless otherwise approved by the Geotechnical Engineer.
- All fill placed at the site shall be compacted to at least 90 percent of the laboratory maximum dry density as determined by ASTM Standard D1557 test method. The on-site soils shall be moisture conditioned at approximate three (3) percent above the optimum moisture content for fine-grained soils and within three (3) percent of the optimum moisture content for coarse-grained soils.
- Representative samples of materials being used, as compacted fill will be analyzed in the laboratory by the Geotechnical Engineer to obtain information on their physical properties. Maximum laboratory density of each soil type used in the compacted fill will be determined by the ASTM Standard D1557 compaction method.
- Fill materials shall not be placed, spread or compacted during unfavorable weather conditions. When site grading is interrupted by heavy rain, filling operations shall not resume until the Geotechnical Engineer approves the moisture and density conditions of the previously placed fill.
- It shall be the Grading Contractor's obligation to take all measures deemed necessary during grading to provide erosion control devices in order to protect slope areas and adjacent properties from storm damage and flood hazard originating on this project. It shall be the contractor's responsibility to maintain slopes in their as-graded form until all slopes are in satisfactory compliance with job specifications, all berms have been properly constructed, and all associated drainage devices meet the requirements of the Civil Engineer.

### ***D1.8 Trench Backfill***

The following specifications are recommended to provide a basis for quality control during the placement of trench backfill.

- Trench excavations to receive backfill shall be free of trash, debris or other unsatisfactory materials at the time of backfill placement.
- Trench backfill shall be compacted to a minimum relative compaction of 90 percent as per ASTM Standard D1557 test method.
- Rocks larger than one inch should not be placed within 12 inches of the top of the pipeline or within the upper 12 inches of pavement or structure subgrade. No more than 30 percent of the backfill volume shall be larger than 3/4-inch in largest dimension. Rocks shall be well mixed with finer soil.
- The pipe design engineer should select bedding material for the pipe. Bedding materials generally should have a Sand Equivalent (SE) greater than or equal to 30, as determined by the ASTM Standard D2419 test method.
- Trench backfill shall be compacted by mechanical methods, such as sheepsfoot, vibrating or pneumatic rollers, or mechanical tampers, to achieve the density specified herein. The backfill materials shall be brought to between optimum and three percent above optimum, then placed in horizontal layers. The thickness of uncompacted layers should not exceed eight inches. Each layer shall be evenly spread, moistened or dried as necessary, and then tamped or rolled until the specified density has been achieved.
- The contractor shall select the equipment and processes to be used to achieve the specified density without damage to adjacent ground and completed work.
- The field density of the compacted soil shall be measured by the ASTM Standard D1556 or ASTM Standard D6938 test methods or equivalent.
- Observation and field tests should be performed by Converse during construction to confirm that the required degree of compaction has been obtained. Where compaction is less than that specified, additional compactive effort shall be made with adjustment of the moisture content as necessary, until the specified compaction is obtained.
- It should be the responsibility of the Contractor to maintain safe conditions during cut and/or fill operations.
- Trench backfill shall not be placed, spread or rolled during unfavorable weather conditions. When the work is interrupted by heavy rain, fill operations shall not be resumed until field tests by the project's geotechnical consultant indicate that the moisture content and density of the fill are as previously specified.

### ***D1.9 Observation and Testing***

- During the progress of grading, the Geotechnical Engineer will provide observation of the fill placement operations.
- Field density tests will be made during grading to provide an opinion on the degree of compaction being obtained by the contractor. Where compaction of less than specified herein is indicated, additional compactive effort with adjustment of the moisture content shall be made as necessary, until the required degree of compaction is obtained
- A sufficient number of field density tests will be performed to provide an opinion to the degree of compaction achieved. In general, density tests will be performed on each one-foot lift of fill, but not less than one for each 500 cubic yards of fill placed.

# Appendix E

Percolation Testing

## APPENDIX E: PERCOLATION TESTING

Percolation testing was performed utilizing exploratory boring BH-4 on August 24, 2017. The continuous pre-soak falling-head test method for water percolation testing was utilized to evaluate soil infiltration rates of the existing and native soils encountered between depths of 0 to 10.0 feet below the ground surface at the respective boring location in accordance with LA County Low Impact Development, Best Management Practices Guidelines. The test location was prepared by placing a perforated 2-inch diameter PVC pipe surrounded by pea gravel after drilling and sampling. Water was filled to the ground surface to pre-soak prior to testing.

The boring was cased using a two-inch diameter perforated casing. Water was added to the bore hole until the water level was as near the ground surface as could be achieved, and allowed to pre-soak for at least 4 hours if the water did not drain entirely within 30 minutes after filling the boring two (2) consecutive times. After pre-soak, water was added to the bore hole until the water level was as near the ground surface as could be achieved. The water level was measured to the nearest 1/8-inch and recorded either every 10 or 30 minutes for three (3) consecutive readings depending on the soils encountered. There were at least four (4) sets of measurements taken for each test and each set consisted of at least three (3) measurements. The results of the percolation tests are tabulated below.

**Table No. E-1, Percolation Testing Result**

Boring No.	Depth of Test (feet)	Soil Types (USCS)	Average Percolation Rate (inches/hour)	Lowest Percolation Rate (inches/hour)
BH-4	0.0-10.0	Silt (ML) over Sandy Silt (ML)	1.74	1.35

In accordance with County of Los Angeles requirements, the minimum percolation rate for design of infiltration system for storm water management is 0.3 inch per hour. It should be noted that per LA County Low Impact Development, Best Management Practices Guidelines, any planned infiltration systems should be at least 10 feet above historically highest groundwater levels. The project Civil Engineer shall review the percolation rates presented for design of the proposed infiltration system. Infiltration system should be properly maintained periodically to minimize sedimentation in the infiltration system.